

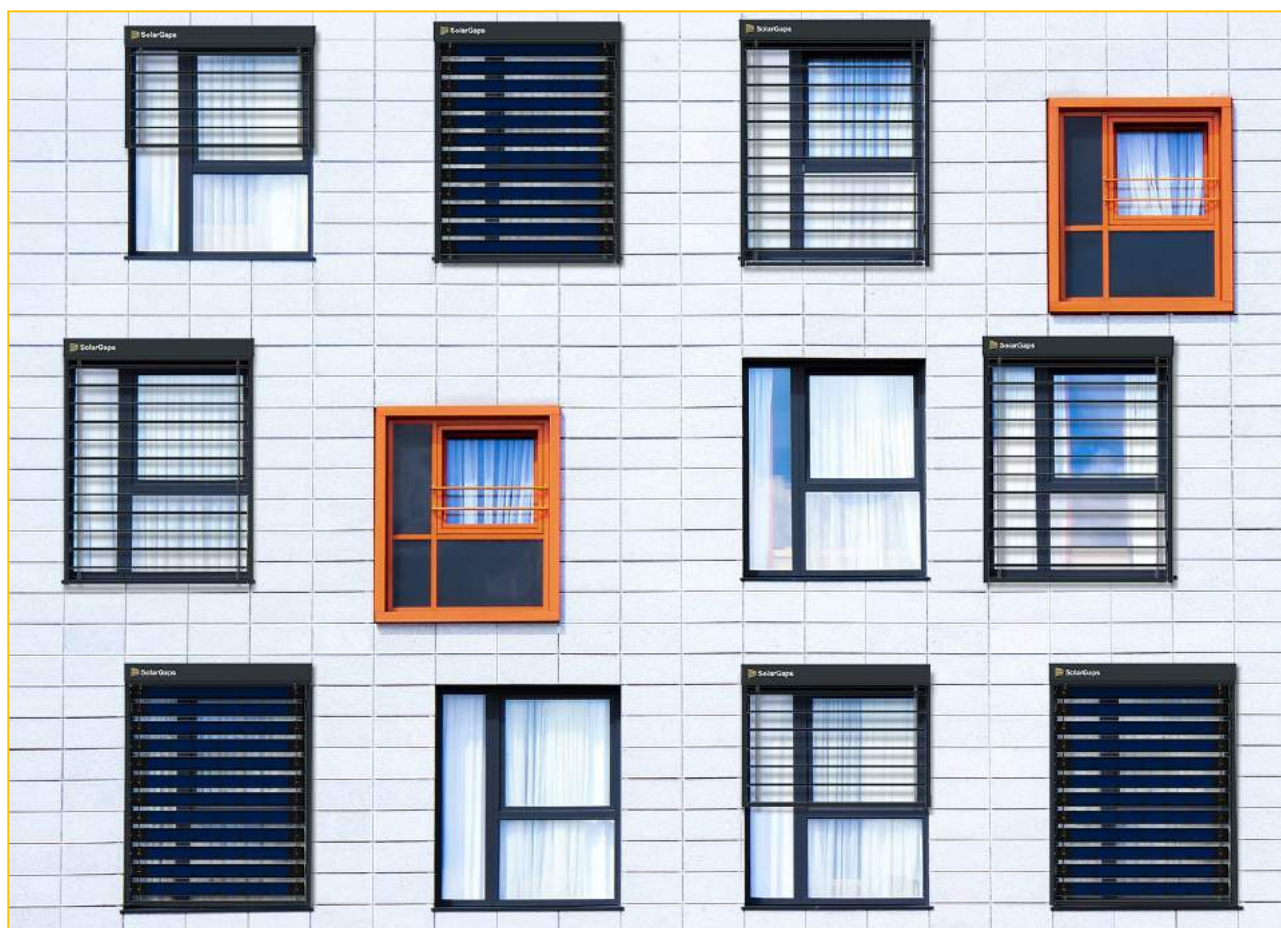

VENETIAN BLINDS WITH SOLAR PANELS



OPERATION MANUAL

Dear Customer!

SolarGaps would like to express its gratitude for your choice!

Our experts use best working practices and modern technologies to ensure efficient utilisation of solar energy as you use our product.

We provide quality control at every production stage: from design of engineering drawings and incoming control of materials and components to outgoing control of finished products and packing of goods for further transportation — with all operations performed by highly qualified personnel.

We strongly recommend you to read this manual carefully before installing and using the product.

YOU CAN RELY ON THE TOP QUALITY OF **SOLARGAPS** PRODUCTS!

CONTENTS

1. Functionality and field of application	EN. 4
2. Reference to standards	EN. 5
3. Technical specifications and product range.....	EN. 6
4. Delivery set	EN. 8
5. Product description and operating principle	EN. 9
6. Preconditions for installation	EN. 11
7. Product installation.....	EN. 16
8. Start-up and adjustment works.....	EN. 22
9. Product testing	EN. 23
10. Mobile Application instructions	EN. 24
11. Transportation rules	EN. 37
12. Storage rules.....	EN. 38
13. Safety instructions	EN. 39
14. Fire safety instructions	EN. 40
15. Operation conditions and useful life.....	EN. 41
16. Maintenance.....	EN. 42
17. Troubleshooting	EN. 43
18. Warranty obligations	EN. 44
19. Disposal.....	EN.47
Annexes:	
1. Warranty Certificate.....	EN.48
2. Declaration of Conformity.....	EN.49
3. Declaration of Performance.....	EN.50

1. Functionality and field of application

The SolarGaps solar panel blinds system (hereafter referred to as the BLINDS) is a smart blinds system using built-in photovoltaic elements, which generate the electrical power. You can use this electricity to power your home appliances, store it in batteries and/or sell the excess amount to your energy supplier. SolarGaps blinds can automatically track the sun all day long, adjusting their position to ensure optimum tilt angles for capture of solar rays and maximum solar energy generation to provide power supply to various devices in your house, apartment or office. SolarGaps blinds are mounted above window opening (outside of apartment, house or office premises) and are capable to generate up to 100 W·h of energy per 1 m² of the window area, which is generally enough to power 30 LED-lamps or three MacBook laptops.

 **WARNING!** Carefully study this Manual before starting installation (mounting) and operation of the product.

 Installation, maintenance and repairs of the product shall be performed only by entities and organizations authorised (licensed) to perform such works or technicians holding an appropriate certificate.

 **PROHIBITED!** It is prohibited to carry out any works related to service and/or repairs of the product without its prior disconnection from the power grid.

 As a result of ongoing activities on improvement of the product by SolarGaps, this document may not cover certain modifications in the design, though any such modification shall by no means deteriorate neither technical specifications, nor design and operational safety of the product.

2. Reference to standards

EN 13561:2015 External blinds — Performance requirements including safety.

EN 13659:2015 Shutters and external Venetian blinds. Performance requirements including safety.

EN 60335-1:2012 Household and similar electrical appliances — Safety — Part 1: General requirements.

EN 60335-2-97:2006 Household and similar electrical appliances — Safety — Part 2-97: Particular requirements for drives for rolling shutters, awnings, blinds and similar equipment.

EN 61000-3-2:2014 Electromagnetic compatibility (EMC) — Part 3-2: Limits — Limits for harmonic current emissions (equipment input current ≤ 16 A per phase).

EN 61000-3-3:2013 Electromagnetic compatibility (EMC) — Part 3-3: Limits — Limitation of voltage changes, voltage fluctuations and flicker in public low-voltage supply systems, for equipment with rated current ≤ 16 A per phase and not subject to conditional connection.

EN 55014-1:2006 Electromagnetic compatibility — Requirements for household appliances, electric tools and similar apparatus — Part 1: Emission.

EN 55014-2:1997 Electromagnetic compatibility — Requirements for household appliances, electric tools and similar apparatus — Part 2: Immunity.

3. Technical specifications and product range

3.1. The BLINDS were designed and are manufactured according to the requirements of EN 13561. The main technical specifications are presented in Table 1.

Table 1

Parameter	Value
Electrical energy generation: - voltage, V - frequency, Hz - specific capacity, W/m ² , minimum - efficiency factor (EF), %, minimum	~ 230 and 110 ± 10% 50 or 60 ± 1 70 19
Adjustment of slat angle: - slat angle adjustment range, degrees - special software application for smartphone	70 to -30 SolarGaps
Power network: - voltage, V - frequency, Hz - rated power consumption, W	207-244 and 110 50 or 60 ± 1 90 to 300
Operation conditions: - working temperature, °C - climate version, placement category 1 - shock resistance	-20 to +65 Moderately cold climate group M3
Reliability indexes - Mean time between failures, hours, min. - total average useful life, years, min	20 000 10
Average specific weight, kg/m ²	10±1



Notes:

- ✔ Depends on the solar radiation intensity.
- ✔ Power consumption during operation of the electric drive for adjustment of slats position. It depends on power of the installed motor, which is determined by operational load according to dimensions of the ordered product (length and number of salts).

3.2. Product range of the BLINDS:

**SGVIC80-6-W-(WxH)(color)(QM); SGVIC80-10-W-(WxH)(color)(QM);
 SGVIC80-20-W-(WxH)(color)(QM); SGVIC80-6-R-(WxH)(color)(QM);
 SGVIC80-10-R-(WxH)(color)(QM); SGVIC80-20-R-(WxH)(color)(QM);**

Marking of the blinds with solar panels – example

SGVIC80 — 10 — W / R — (WxH) (color) (QM)

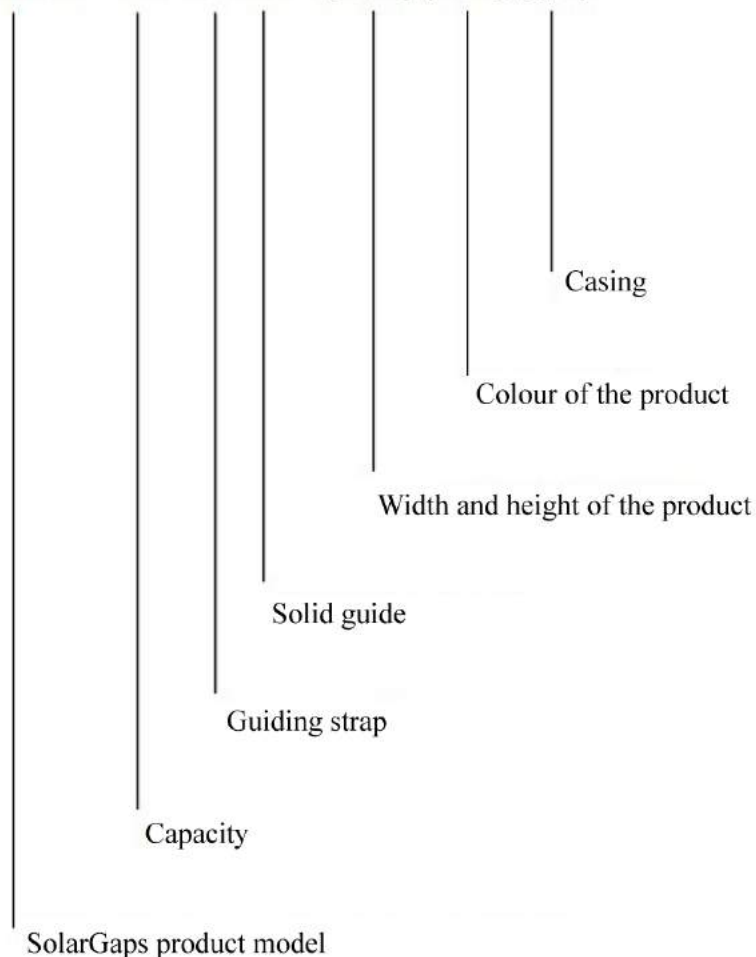

4. Delivery set

- SolarGaps BLINDS with solar panels1 set
- operation documents (Manual)1 pcs.
- packing1 pcs.

5. Product description and operating principle

5.1. Product description

- 1** – casing containing electric drive motor, mechanisms and control unit installed under cornice;
- 2** - mushroom-shaped brackets;
- 3** - slotted side guides;
- 4** – slats with solar cells and guiding rollers;
- 5** - ladder cords (2 pcs.) — to adjust the tilt angle of slats with solar cells;
- 6** - straps (2 pcs.) passing through holes in slats with solar panels to move the entire blinds web up and down;
- 7** - bottom rail — to fix cords and straps.

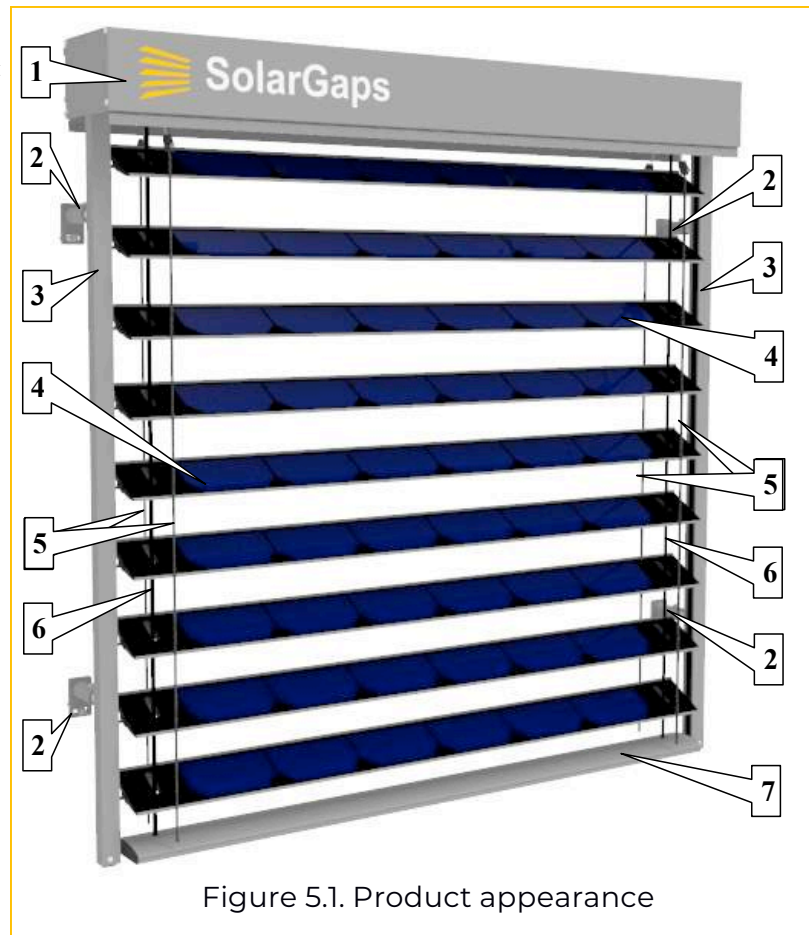

Figure 5.1. Product appearance

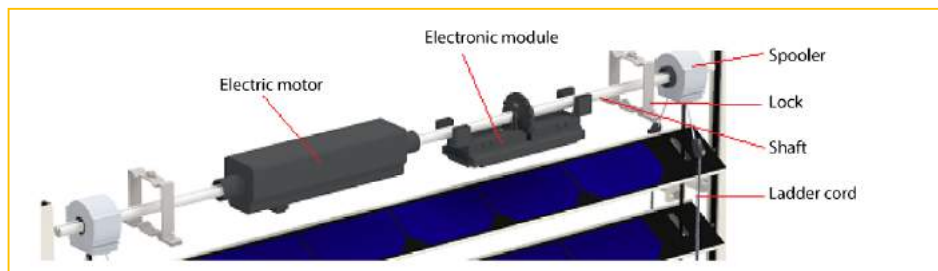

Figure 5.2. Arrangement of elements under the casing

5.2. Main elements of the BLINDS

5.2.1. Slats carrying attached solar panels that convert solar energy into direct current electric power. The number and length of slats depend on the dimensions of ordered BLINDS.

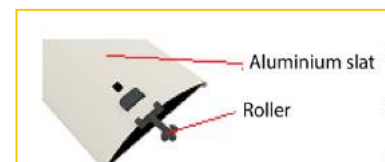

Figure 5.3. Slats

5.2.2. Mechanism for moving slats with solar panels up and down and adjusting the tilt angle. The mechanism is mounted in the cornice under the casing. It consists of electric drive (motor), shaft and supports (number of supports depends on the slat length, min. 2 pcs.)



Figure 5.4. Electric motor

5.2.3. Slotted side guides (2 pcs.) ensure free motion of slats with solar panels during operation



Figure 5.5. Slotted side guides

5.2.4. The electronic module installed in the casing receives commands transmitted by a smartphone via official application to control electric motor of the BLINDS, controls output voltage of solar panels and is connected to power consumption and accumulation circuit for appliances, which use the generated power.



Figure 5.6. Electronic module

5.2.5. The inverter converts generated power from DC to AC (~ 230 V 50 Hz) or (~ 110 V 60 Hz) used as power supply for the majority of home appliances. Besides, if needed, it allows connecting these consumers to the external power grid, or vice versa – supplying the excess generated energy to the grid, which gives the right to respective compensation according to the law. The connection cable for the inverter is attached through cable duct QM.



5.2.6. The battery, which can be incorporated into the BLINDS system, allows optimizing power supply of the house through redistribution of accumulated and consumed electrical energy.

i The BLINDS are controlled via Wi-Fi by using special mobile application and automatically adjust the tilt angle of slats with solar panels, while tracking the sun position to ensure the maximum power generation.

6. Preconditions for installation









 **WARNING!** It is recommended to read the technical description before proceeding with the installation (mounting) and start-up and adjustment works to be performed prior to operation of the BLINDS.

6.1. It is recommended to install the BLINDS **outside of the building** over a window or any other transparent aperture. Only this mounting position together with appropriate slat tilt angle adjustment can ensure optimum utilization of all advantages provided by the BLINDS:

-  protection from direct sunlight by preventing the rays from entering the room;
-  conversion of solar radiation into electrical power for further consumption along with the room dimming.

 If you get professional advice on compatibility of equipment made by different manufacturers, the BLINDS may be easily integrated into a single Smart House system, in which multiple household processes are automated and controlled via centralized services such as Google Home or Amazon Alexa.

 During the **purchase/sale** of the BLINDS (before installation of the product) the Buyer is recommended to:

-  check for absence of damages of the transportation packing by visual inspection;
-  carefully remove the packing material in a way not to damage components of the BLINDS;
-  check the received product for conformity with the order;
-  check the completeness of the product;
-  make sure that the **Warranty Certificate** is properly filled, free of alterations, has an indication of the date of sale, bears the Seller's stamp and signature of the sales person;
-  check the availability of a document confirming the fact of purchase-sale of the BLINDS;
-  record information on all revealed discrepancies, damages or missing components of the BLINDS in the delivery receipt or delivery note;
-  file a claim to the transportation company, if any discrepancies and/or violations have been found. If the product was received from a distributor, the claim shall be presented directly to the distributor.

 **NOTE:** The Manufacturer will not accept any claims relating to missing components and physical damages to the product, as well to the absence of abovementioned documents or their incorrect or unclear wording after installation of the BLINDS.

 **WARNING!** Install the BLINDS according to legal and construction requirements for installation of sun louvres (external blinds) in effect in your country.

-  Design, materials and components used in the product exclude the option of **indoor** installation and operation of the BLINDS.



CAUTION! The BLINDS contain components supplied by electrical power (~230 V 50 Hz and ~110 V 60 Hz) or generating it. Therefore, wiring and connection to the grid shall be performed by an authorised electrical technician having an appropriate permit.

6.2. The Buyer is recommended to take into account the following factors prior to installing the product:

6.2.1. In case of a new construction, it is desirable to include installation of the BLINDS in the construction project in advance. In this case all installation and start-up issues will be settled by the Constructor based on the contract with the End User/Buyer of our product.

6.2.2. If a building already exists, it is recommended to order installation of the BLINDS to companies that have permits (licenses) for such works (including Working At Height Permit) or appropriately certified personnel.

6.2.3. If the Buyer intends to install the BLINDS and perform start-up works- to the highest standard by himself, he will need:

- ✓ advanced skills of using tools;
- ✓ personal experience in performing elevated jobs and proper equipment;
- ✓ favourable climate conditions (temperature, humidity, rain, snow, wind, dust rate, smoke, natural lighting, etc.).



CAUTION!

- ✗ All risks during the independent installation and start-up works performed by the Buyer shall be borne by the Buyer, and the Manufacturer and/or Seller shall bear no responsibility in this case.
- ✗ Improper fixing and other installation errors, specifically under extreme environmental conditions (icing, vibration, etc.) may cause product falling and result in damage to property, health or even danger to lives of people or animals.

6.3. The Buyer/End User must choose the BLINDS installation option before ordering the product model, since it is related to dimensions of the BLINDS. The main installation options for the product include:

6.3.1.



If the building is already built, the BLINDS may overlap the face of the building, as follows:

- slotted side guides are fixed at both sides of the aperture;
- the casing is fixed above the aperture.

This layout is easily implemented but is less resistant to external impacts (natural disasters, vandalism).

6.3.2.

If the BLINDS are installed into the window aperture, a certain useful light-transmitting window area is lost, as it is shielded by the casing. Besides, the casing with mechanisms and slotted side guides become visible from inside. However, this type of installation is more resistant to external impacts.



6.3.3. The key factor of optimum installation is compliance of the ordered and received model of the BLINDS with the chosen installation option.

6.4. High-quality preparation of the window aperture is an essential precondition for installation of the BLINDS with minimum expenses, namely:

- ✔ the window aperture shall be rectangular in shape;
- ✔ the working surface of aperture shall be plain and smooth without plaster sags and cracks;
- ✔ any deviation of the working surface area from vertical and horizontal position shall not exceed 1.5 mm/m and 5 mm in total. The difference between lengths of diagonals shall not exceed 5 mm.



Notes:

- ✔ To perform exact measurements, use a metal tape measure. Take measurements in millimetres in the width × height format.
- ✔ Measure each window since they may have slightly different dimensions.
- ✔ Do not take measures from the building plan since they may be inaccurate.
- ✔ Decide whether you prefer Overhung (larger than the window aperture) or Innerhung (within the window aperture) BLINDS installation method.

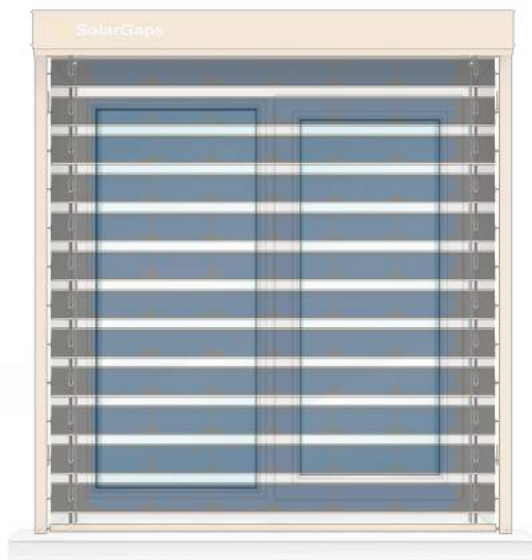

Overhung



Innerhung

6.5. Taking measurements for the Innerhung (BLINDS within the window aperture) installation method.

If you want to fit / fix / hang BLINDS within the window aperture, you have to measure the internal size of the aperture (aperture size that is precise window height and width.)

- H** Measure the wall-to-wall window width in three locations.
- ✓** Record the shortest width measurement
- V** Measure the height from the upper part of the windows aperture to the window sill in three locations.
- ✓** Record the shortest height/drop measurement.
- T** Tolerance to be taken into account when taking width measurements. Tolerance shall be at least 7 mm.

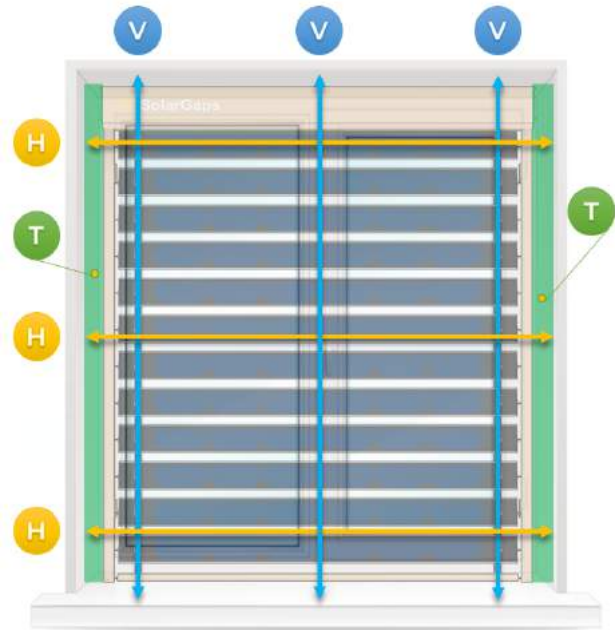

6.6. Taking measurements for the Overhung (BLINDS exceed the window aperture) installation method.

Follow the instructions below if there is an architrave in the window aperture.

- H** Measure the width from one architrave edge to the opposite one.
- V** Measure the height from the architrave top to the location, which you plan to be the lowest point for your BLINDS.
- ✓** Record the measurement results.

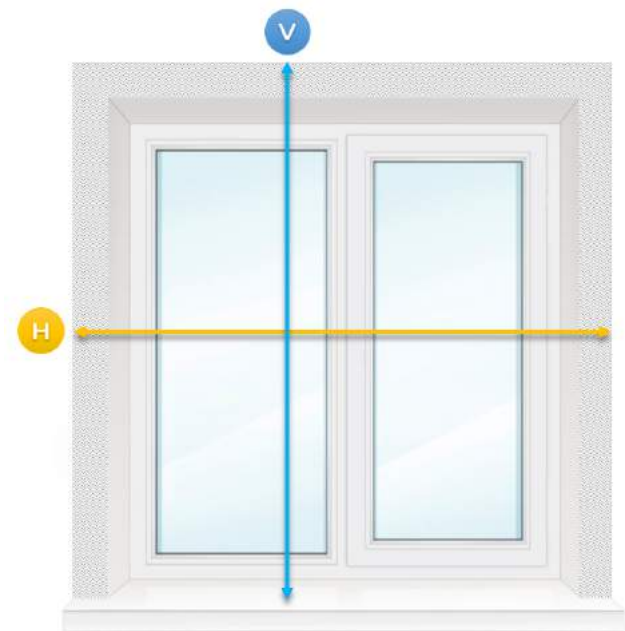

If there is no architrave, perform the following steps

- H** Measure the width from one edge of the window aperture to the opposite one.
- V** Measure the height from the window aperture top to the location, which you plan to be the lowest point for your BLINDS.
- ✓** Record the measurement results.

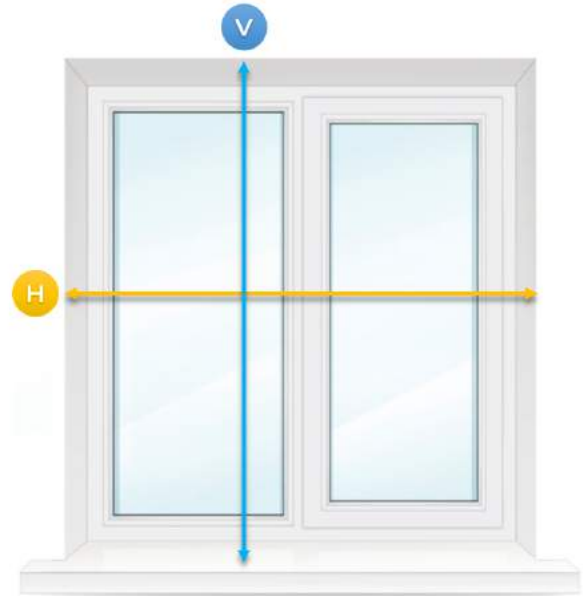

Notes:

Take into account different blind types. To ensure the maximum privacy and the minimum light break, it is recommended that the BLINDS extend over the bottom and both sides of the window opening.



CAUTION!

When making an order, be sure to specify the BLINDS installation method for which the measurements were made.

7. Product installation

7.1. General sequence of operations for installation of the BLINDS is as follows:

- ✔ install and fix the cornice that contains properly fixed casing with electric motor, mechanisms and control unit with the help of latch brackets;
- ✔ insert guiding rollers of slats with solar panels into slotted side guides;
- ✔ install the slotted side guides and fix them with mushroom brackets;
- ✔ drill holes for electrical cables;
- ✔ install indoors and properly fix the inverter and battery (if a battery is incorporated in the BLINDS system);
- ✔ perform electric wiring according to the current standards.

⚠ CAUTION! Perform installation taking into account material properties of walls of the building, where the BLINDS are to be mounted, as well as the window design and materials, if the product is to be mounted into the window aperture. Therefore, use proper tools and fixings (rods, anchors, screws, etc.) that are resistant to corrosion and climatic impact to ensure secure attachment of the product under operation conditions.

7.2. Install the cornice with casing containing electric motor, mechanisms and control unit as follows:

7.2.1. Mark out points for holes to fix latch brackets on the prepared working surface making sure to locate them at equal intervals and ensuring horizontal position of the casing and cornice.

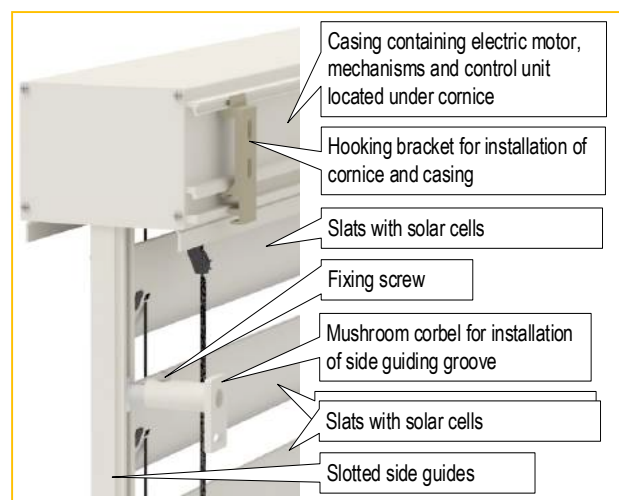

7.2.2. Make holes to fix the latch brackets depending -on the installation place, i. e.:

- ✔ for concrete, stone or solid brick walls — Ø 8 mm holes using a **rotary hammer**, e. g. REDIBOLT-N 8x120/M6/75 anchor and a yellow zinc plated nut or equivalent;
- ✔ for aerated concrete walls — Ø 6 mm holes using a **drill** for a sleeve anchor used together with a screw, e. g. TGS 8x60/5.0-6.0 anchor (yellow zinc plated) and DIN571 6.0x100 screw or an equivalent set of fixing elements of a proper material;
- ✔ for wooden walls — Ø 4 mm holes using a **drill** for a stainless steel screw, e. g. DIN571 6.0x100 screw for Group 6 A2 wood or equivalent;
- ✔ for metal window frames — use a self-tapping screw **without drilling a hole**;
e. g. for frames made of stainless steel, use TEX-Him 6.3x38C1 screw as per ISO 15480 or equivalent.

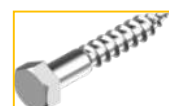
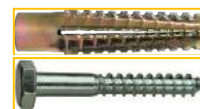

7.2.3. Fix the latch brackets to the working surface using an appropriate fixing method

(by anchor or screw) in accordance with para. 7.3.2 of this Manual.

See Figure on the right →

7.2.4.

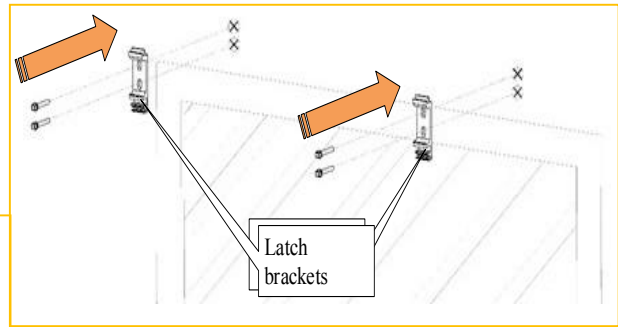
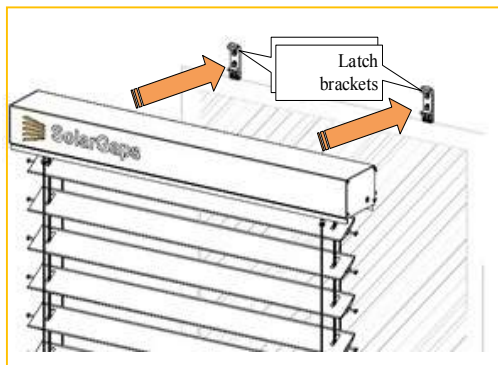

Hang up the cornice with casing on the latch brackets.

← See Figure on the left.

NOTE: The package of BLINDS includes a hard casing made of extruded aluminium alloy and a cornice made of high strength aluminium section. Therefore, installation is highly simplified since the latch brackets can be fixed on walls or window frames in **convenient places**.

7.3. Install the slotted side guides as follows:

7.3.1. Mark out points for holes to fix the mushroom brackets taking into account the following requirements:

- ✔ offset from the end of a guide ~ 100 mm;
- ✔ equispaced locations of brackets;
- ✔ vertical position of the guides.

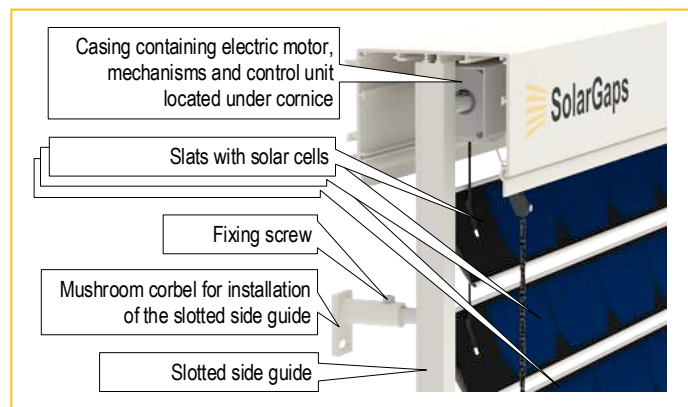

7.3.2. Drill holes to fix the mushroom brackets -the same way as in para. 7.2.3 of this Manual.

7.3.3. Fix the mushroom brackets to the working surface using an appropriate fixing method (by anchor or screw) in accordance with para. 7.2.3 of this Manual.

See Figure on the right →:

7.3.4. Insert **guiding rollers** of slats with solar cells into slotted side guides in a way to ensure free motion of the slats under operating conditions.

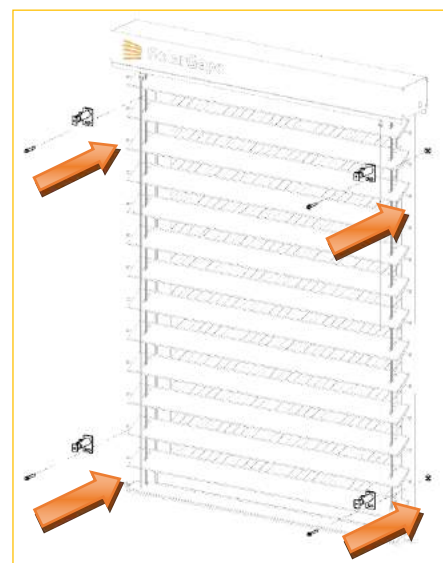

7.3.5.

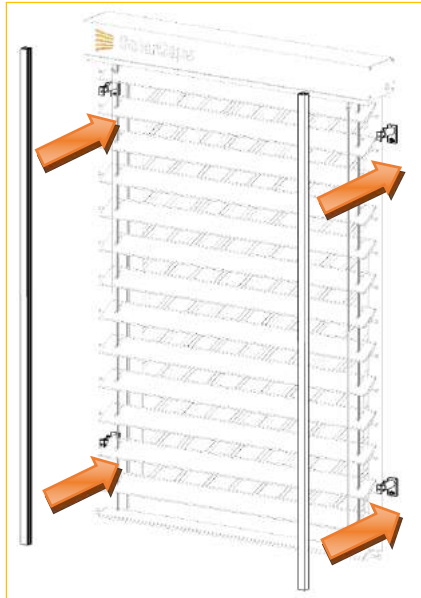

Insert caps of the mushroom -brackets into respective slots in the slotted side guides and fix them on the mushroom -brackets with fixing screws.

← See Figure on the left.

NOTE:

Mount the slotted side guides made of aluminium section with inserts for smoother sliding of rollers of the slats with solar cells with **blind plugs facing down**.

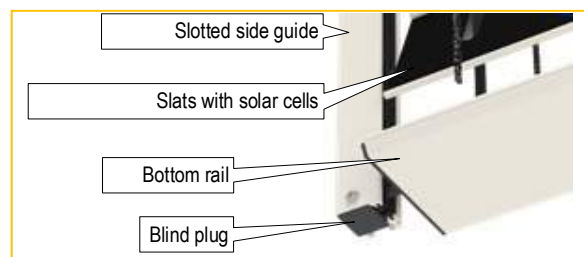

7.4. Connect the BLINDS to the grid, inverter and battery (if the latter is incorporated into the BLINDS system) as follows:

7.4.1. Mark out a point for a wiring hole to bring electrical cables into the room in which the following items are to be installed:

- ✔ sockets for connecting the BLINDS to the grid;
- ✔ inverter from the product set;
- ✔ battery, if the latter is incorporated into the BLINDS system.

7.4.2. Drill a Ø 8-10 mm hole for electrical cables as described in para. 7.2.2 of this Manual.

7.4.3. Bring the above-mentioned electrical cables into the room and fit them with appropriate connectors (plugs) supplied as part of the set.

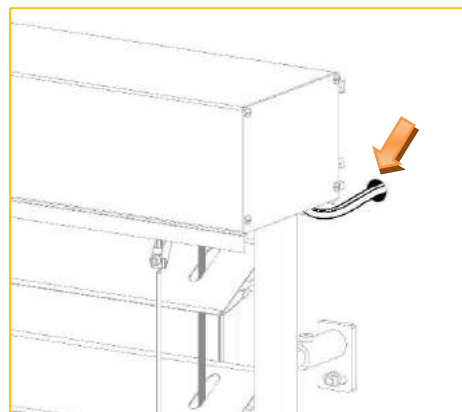

7.4.4. Connect the motor cable to a plug from the product delivery set (see figure to the right).



7.4.5. Connect the electric cable to inverter connectors from the product delivery as follows:

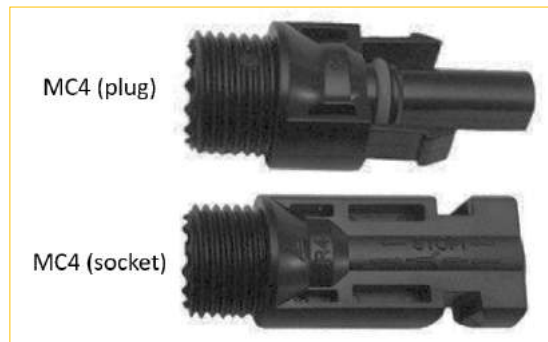

- ✔ Strip off insulation at the end of each wire.
- ✔ Slip the plug pin onto the striped wire end.
- ✔ Crimp the pin using a special tool.
- ✔ Force the plug onto the pin until you hear a distinctive click. Make sure the pin is firmly fixed in the plug.
- ✔ Put the cap onto the plug housing and tighten it firmly.



- ✔ Slip the socket pin onto the striped wire end.
- ✔ Crimp the pin using a special tool.
- ✔ Force the socket onto the pin until you hear a distinctive click. Make sure the pin is firmly fixed in the socket.
- ✔ Put the cap onto the socket housing and tighten it firmly.



- ✔ Put heat shrink tube of appropriate diameter (5 mm) on wires with connectors.
- ✔ Put on heat shrink tube of appropriate diameter (9.5 mm) on the wire to be connected to MC4 connectors.
- ✔ Solder plug connector (marked with '+' on the housing) to core marked with '2' on the insulation.
- ✔ Solder socket connector (marked with '-' on the housing) to core marked with '1' on the insulation.
- ✔ Pull on heat shrink tube over the soldered joints and heat up using a hot air gun.
- ✔ Pull on heat shrink tube (9.5 mm in diameter) over the soldered joints (to improve the appearance) and heat up with a hot air gun again.



7.4.6. Install and properly fix the inverter and battery in the room in places chosen taking into account the length of respective electrical cables (DC).

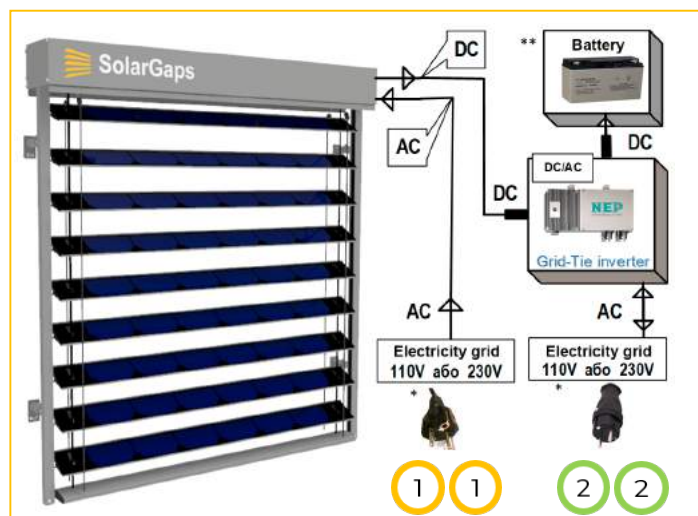

Diagram for connection of the product

* - Depending on the country of delivery, the system may be fitted with different plugs or adapters.

** - The system may be optionally equipped with a rechargeable battery.

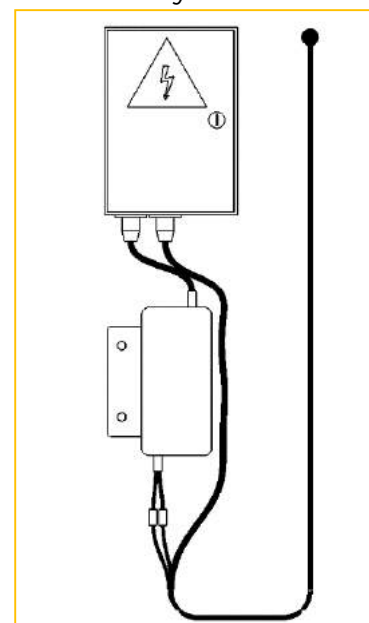

7.4.7. Attach the connectors, fitted in accordance with para. 7.4.3 of the Manual, as follows:

- ✔ DC output of the BLINDS — to the inverter and battery;
- ✔ AC input of the BLINDS and AC output of inverter — to the grid using plugs.



 **NOTE:**

✔ It is necessary to have two free sockets for connection of the BLINDS (see Figure showing connection of the product):

-  socket for power supply to the product;
-  socket for power output to the grid.

✔ Connect the BLINDS to the grid using a socket with grounding contact;

✔ if necessary, use an extension cable or perform wiring works to install an equivalent individual socket according to the current standards. Provide power supply from the grid through a power cable with cross-section that corresponds to the current strength at maximum capacity of the BLINDS (consumed and generated), but at least 0.5 mm², and having an separate insulated grounding wire;

✔ ensure resistance of not more than 0.1 Ohm between the grounding element and any other metal part of the BLINDS, which may potentially be touched- and where dangerous voltages can be present.

**NOTE:**

Use the BLINDS with the installed inverter only.

**CAUTION!**

 The BLINDS contain components supplied by electrical power (~230 V 50 Hz and ~110 V 60 Hz depending on the current standards). Therefore, wiring and grid connection shall be performed by an authorised electrical technician having an appropriate license (permit).

 The BLINDS generate electric current when rolled down, therefore wiring works should be performed with the BLINDS rolled up and disconnected from the grid.

 Connectors on the DC output terminal of the inverter and battery, depending on the package, may be without a plastic casing, only with metal contacts. In this case, in any case, **do not allow metal contacts to touch each other.**

8. Start-up and adjustment works

8.1. Control the BLINDS using a smartphone running iOS 11 or higher. Android smartphones shall use 4.4 Kitkat (API level 19) or higher.

8.2. High quality Wi-Fi signal is needed to ensure reliable control of the BLINDS. At that, the communication speed shall be above 1 Mbit/s and RSSI value shall be in the range 0-74 dBm.

8.3. Control the BLINDS using special SolarGaps smartphone application.

8.4. To download the application, go to Apple Store or Google Play respectively.

8.5. After installing the application, follow the menu instructions to perform all the necessary operations consequently.

8.6. Check in the application setup menu, whether the BLINDS require firmware update. If it is necessary, upgrade the BLINDS firmware version using the application.

8.7. If you fail to perform any operation required by the application menu, send a request to **support@solargaps.com**.



NOTE:



The control unit of the BLINDS converts data received from the smartphone through Wi-Fi into respective signals of certain voltage, which are sent to the electric motor. The motor carries out direct control of mechanisms of the BLINDS.



Manufacturer's recommendation:

It is necessary to have the updated firmware and application version to ensure the best performance of the BLINDS.

9. Product testing

9.1. Installation of the BLINDS and start-up works are considered to be completed only after mandatory functionality check of the product with the use of appropriate controls and devices.

9.2. First of all, check the following:

- ✔ slats move easily and smoothly up and down and change their tilt angle (open/close), and may be fixed in any end or intermediate positions;
- ✔ the tilt angle of slats shall be automatically adjusted during daylight hours to ensure the maximum power generation efficiency in accordance with the stated product specifications.

⚠ **CAUTION!** In case of any failures of the BLINDS or other problems or concerns, stop the start-up works immediately and contact the Seller and/or Manufacturer.

⚠ **IT IS PROHIBITED:**

- ✘ to make any unauthorized modernization and/or introduce any changes to layout, design or installation of the BLINDS;
- ✘ to hinder movement of the slats (up/down, change of the tilt angle) with your hands or other objects.

⚠ **WARNING:** The warranty for the BLINDS does not cover, among others, the following cases:

- ✘ improper installation and/or connection of the product;
- ✘ readjustment, change of construction and/or technical design and alteration (modernization) of the product that are not authorized or approved by the Manufacturer;
- ✘ overload of the BLINDS resulting from incorrect assessment of the voltage and/or power of devices consuming the electrical power generated by the product;
- ✘ product breakage resulting from its connection to the grid, which does not comply with the requirements specified in the technical certificate for the product.

⚠ **WARNING: *In no event will the Manufacturer be liable for:***

- ✘ any -special, accidental, penal or indirect losses of any -type, including without limitation income or profit loss, damage to property and claims of the Buyer (End User) or any -other third parties, even if the Manufacturer has been informed about the possibility of such losses;
- ✘ for any potential damage caused by the product directly or indirectly to people, animals or property, if it results from violation of the rules or conditions of installation, testing or operation of the BLINDS, or intentional or unintentional actions of the Buyer (End User) or any other third parties.

10. Mobile Application instructions

10.1. First connection to the Application

10.1.1. Open SolarGaps Application (*Fig. 1*).

10.1.2. Get registered in the app by entering your **email** or log in using your **Facebook** or **Google** account.

10.1.3. If you are already a registered user, click **Sign in**.



Figure 1

10.2. Connecting to the blinds for the first time

The app is designed to control several BLINDS located within the same House/Home. To optimize performance of the solar panels, the application ensures control by rooms. If only one set of BLINDS is installed in a House, you should define the room for the BLINDS.

 Prior to the first connection make sure that the BLINDS are plugged to two sockets as follows:

-  - power supply socket
-  - socket for electricity output into the power grid

To connect the application to the BLINDS, go through all consecutive connection steps:

Installation, Setup Home, Connect, Setup Wi-Fi (*Fig. 2*).

10.2.1. Click **Installation** to confirm connection of the BLINDS to the home and then click **Done** (*Fig. 3*).

10.2.2. Click **Setup Home** to connect the home to the BLINDS (*Fig. 2*), define home name and click **Done**.



Figure 2

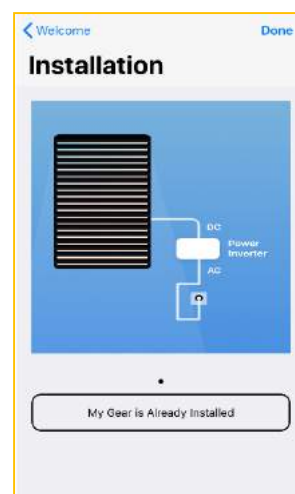

Figure 3

10.2.3. Click **Connect** to connect the BLINDS to Bluetooth (Fig. 2):

10.2.3.1. Make sure that Bluetooth is enabled on your smartphone and click **Ok** (Fig. 4).

10.2.3.2. The application is searching for the BLINDS (Fig. 5).

10.2.3.3. As soon as the BLINDS appear on the screen, swipe them to **Drop Blinds Here** (Fig. 6).

10.2.3.4. Click **Done** to confirm the connection (Fig. 7).

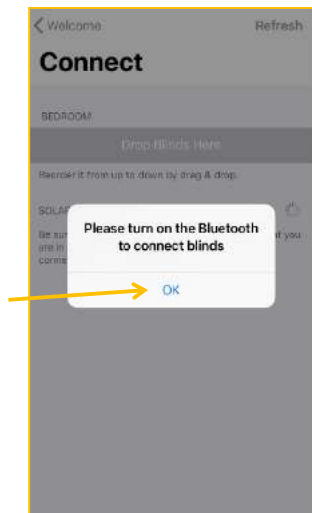

Figure 4

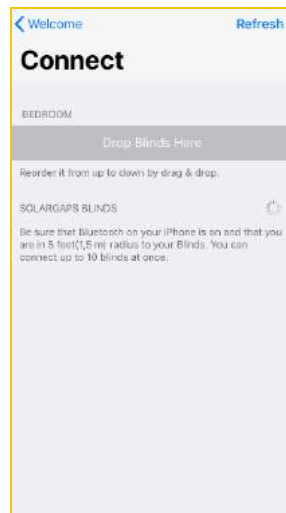

Figure 5

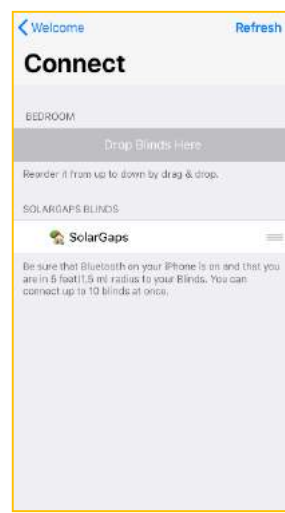

Figure 6

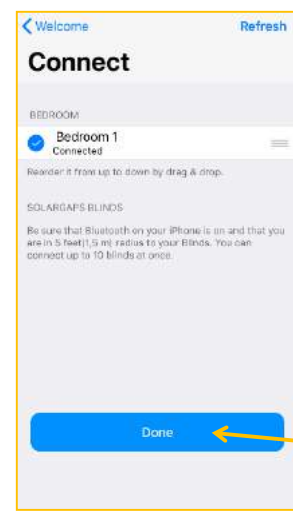

Figure 7

10.2.4. Click **Setup Wi-Fi** to connect the BLINDS to Wi-Fi (Fig. 2):

10.2.4.1. Select the name of your WiFi network from the list of available connections and enter the password (Fig. 8).

10.2.4.2. The application gets connected to the network, it may take some time (Fig. 9-10).

10.2.4.3. After successful connection to Wi-Fi, **Great** key appears on the screen (Fig. 11). Click it to start operation of the BLINDS.

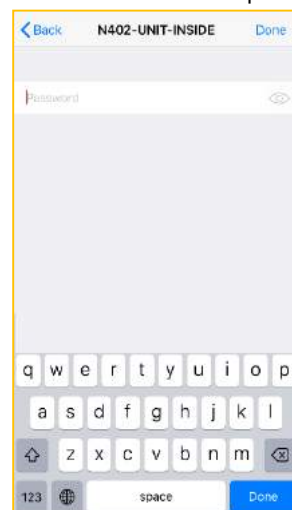

Figure 8

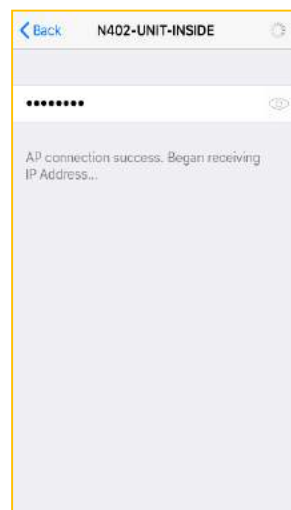

Figure 9

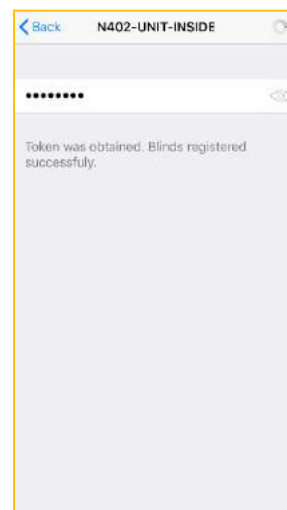

Figure 10

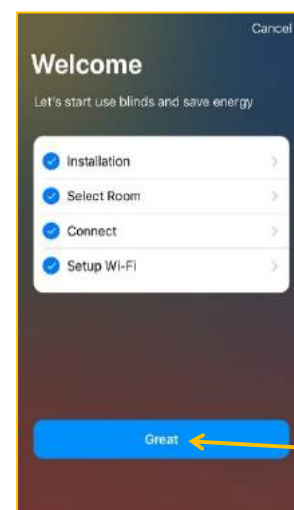

Figure 11

⚠ WARNING: The stability of BLINDS control depends on the quality of Wi-Fi signal. At that, the communication speed shall exceed 1 Mbit/s and RSSI range shall be 0-74 dBm.

- ✔ Check Wi-Fi communication speed - [Speedtest](#)
- ✔ Check RSSI range – [Android](#), [IOS](#)

10.3. Overview of application homepage – Home (Fig. 12)

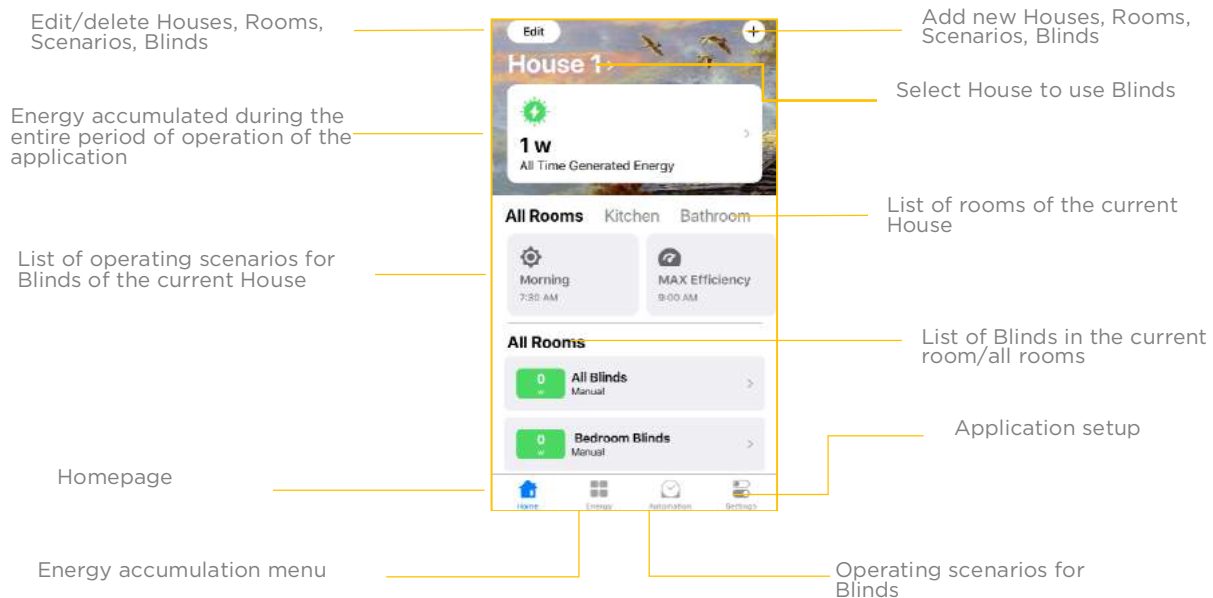

Figure 12

10.4. Connection of blinds to the application

10.4.1. Click **+** in the top right corner to start (Fig. 13) and select **Blinds** tab or click **connect blinds** in the homepage (Fig. 14).

10.4.2. Proceed with the connection procedure (Fig. 15):

- ✔ **Installation** – confirm installation of the BLINDS
- ✔ **Select Room** – select the room, where the BLINDS are installed
- ✔ **Connect** – connect the phone Bluetooth to the BLINDS
- ✔ **Setup Wi-Fi** – connect the BLINDS to your Wi-Fi network

After successful connection to Wi-Fi, **Great** key appears on the screen. Click it to start operation of the BLINDS.

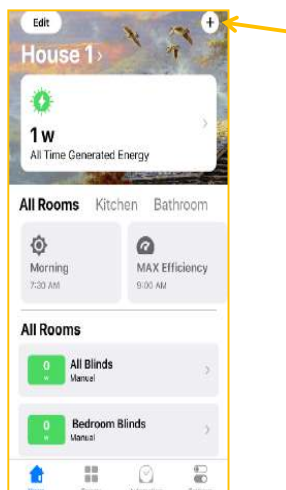

Figure 13

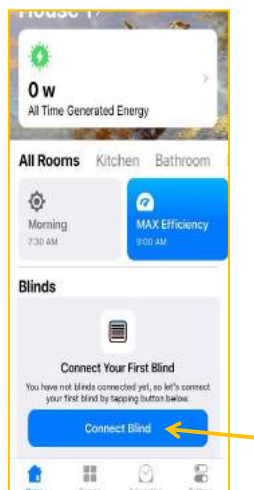

Figure 14

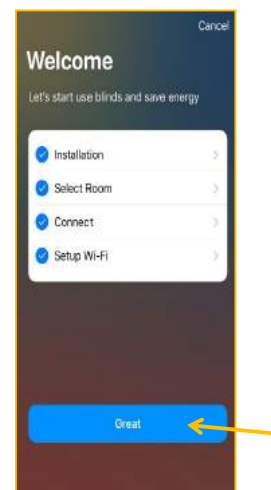

Figure 15

10.5. Setting up a new house for use of blinds

10.5.1. Click **+** in the top right corner to start (Fig. 16).

10.5.2. Select **Home** from the menu options (Fig. 17).

10.5.3. Fill in the required fields (Fig. 18):

- ✔ **Home Name** – enter the home name
- ✔ **Add Room** – add room/rooms
- ✔ **Time Zone** – select the time zone
- ✔ **Background** – select background for homepage of the home

10.5.4. Click **Save** to save changes (Fig. 19).

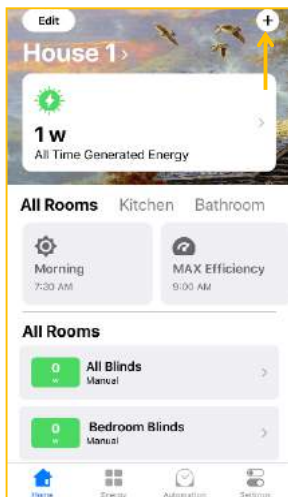

Figure 16

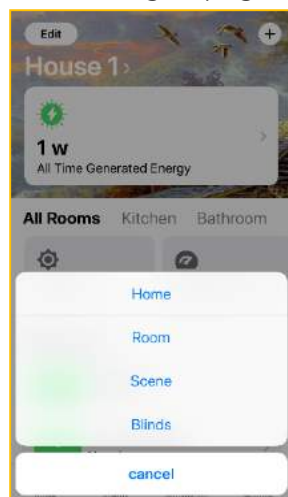

Figure 17

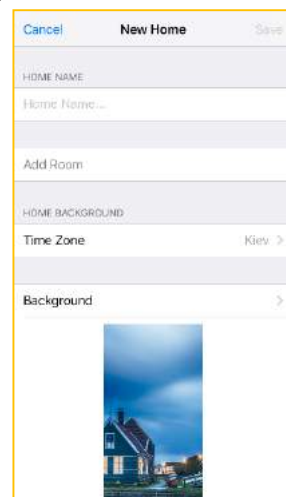

Figure 18

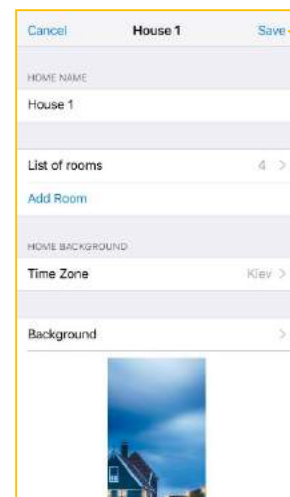

Figure 19

10.6.1. Click **+** in the top right corner to start (Fig. 20).

10.6.2. Select **Room** from the menu options (Fig. 21).

10.6.3. Fill in the required fields (Fig. 22).

✔ **Add to** – attributes the room respective house

✔ **Room Name** – enter the room name

10.6.4. Click **Save** to save changes.

The newly created room will appear on the app homepage (Fig. 23).

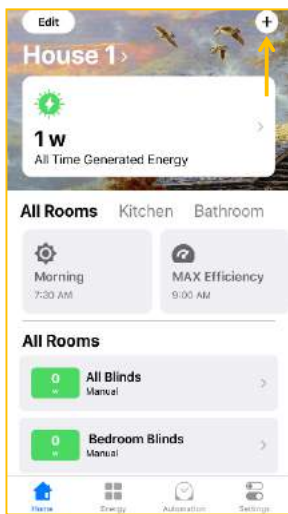

Figure 20

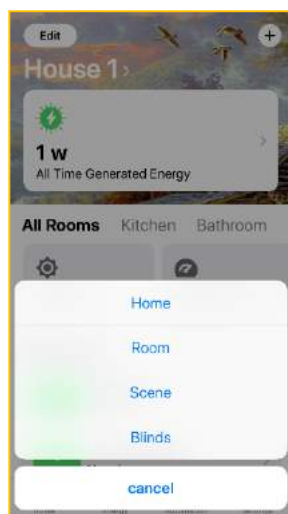

Figure 21

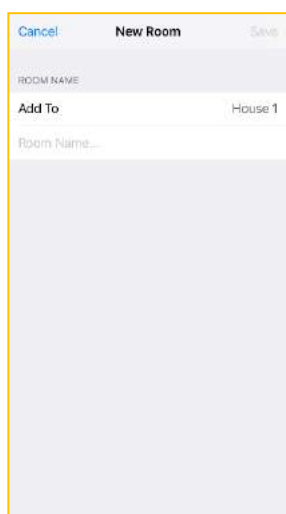

Figure 22

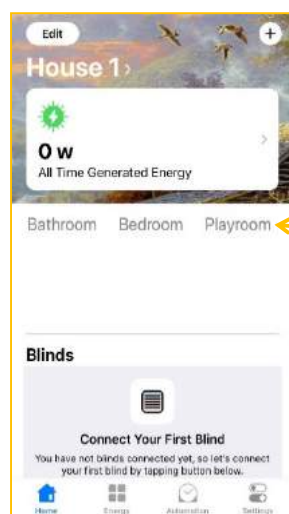

Figure 23

10.7.1. Click **+** in the top right corner to start (Fig. 24).

10.7.2. Select **Scene** from the menu options (Fig. 25).

10.7.3. Fill in the required fields (Fig. 26):

✔ **+** - select icon for the scenario

✔ **Scene Name** – enter the scenario name

✔ **Add Blinds** – add BLINDS to be operated based on the new scenario. You may choose BLINDS in a certain room or all BLINDS of the house.

✔ **MAX. Efficiency** – click this key, if you want to use the BLINDS with maximum efficiency.

ℹ This scenario allows the BLINDS to change the tilt angle or position automatically depending on the sun motion, which ensures maximum power generation.

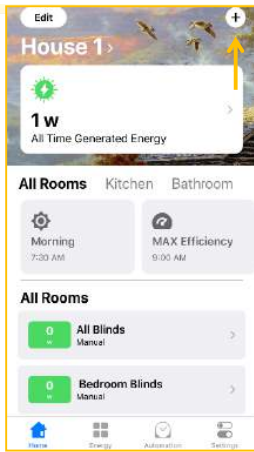

Figure 24

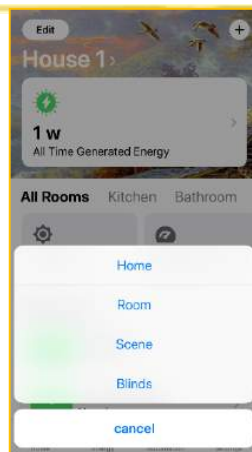

Figure 25

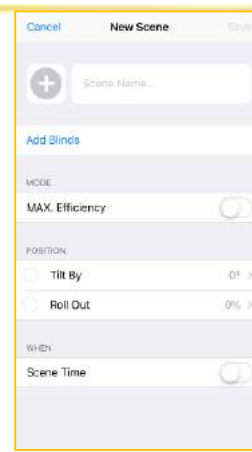

Figure 26

- ✔ **Tilt By** – change the solar panels tilt angle by dragging “points” on the “virtual window” (available only if **MAX. Efficiency** is disabled) (Fig. 27).
 - ✔ **Roll Out** – roll the BLINDS up/down to desired height in the “virtual window”, where 100% is fully open and 0% is fully closed position (available only if **MAX. Efficiency** is disabled) (Fig. 28).
 - ✔ **Scene Time** – click to enter hours and days for execution of the scenario (Fig. 29).
- 10.7.4.** Click **Save** to save changes (Fig. 30).

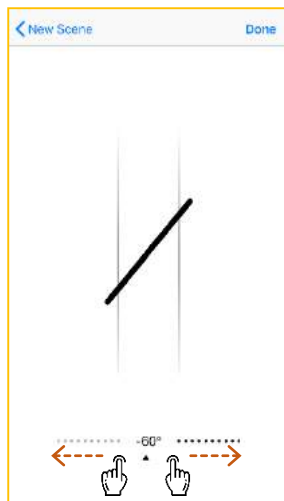

Figure 27

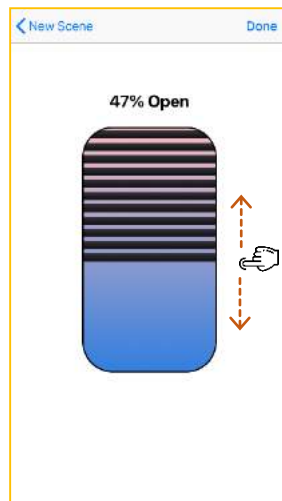

Figure 28

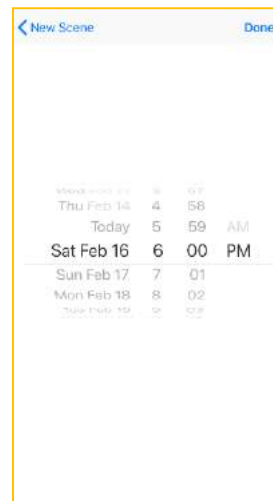

Figure 29

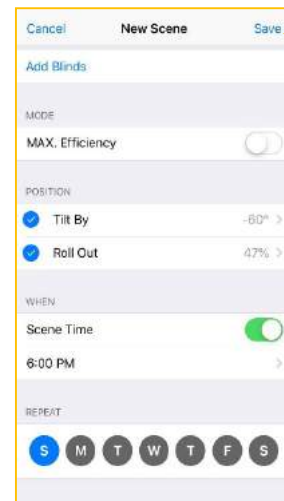

Figure 30

10.8. Edit features of the current home

10.8.1. Click **Edit** tab in the top left corner to start (Fig. 31).

10.8.2. Select **Home** from the menu options (Fig. 32).

10.8.3. Edit appropriate data (Fig. 33):

✔ **Home Name** – edit the home name

✔ **List of rooms** – change the number of rooms by deleting rooms with **Edit** button.

To change the room name, enter the room description tab and click the room name. Click **Save** to save changes.

✔ **Add Room** – add a new room to the Home

✔ **Time Zone** – change the time zone

✔ **Background** – change the homepage background

10.8.4. Click **Save** to save changes.

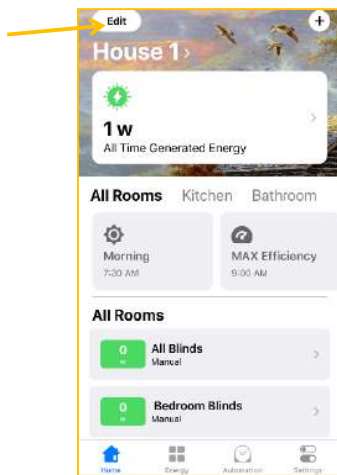

Figure 31

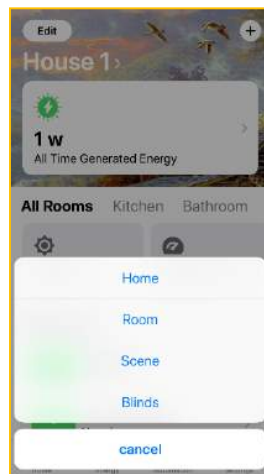

Figure 32

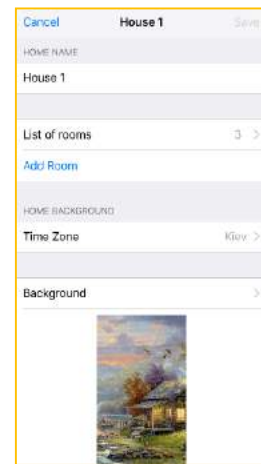

Figure 33

10.9. Edit/create rooms

10.9.1. Click **Edit** tab in the top left corner to start (Fig. 34).

10.9.2. Select **Room** from the menu options (Fig. 35).

10.9.3. Select a room, which name you want to change (Fig. 36) and click **Save** (Fig. 37).

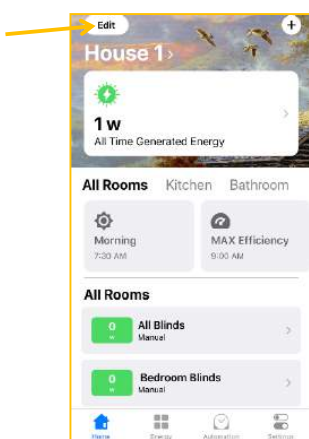

Figure 34

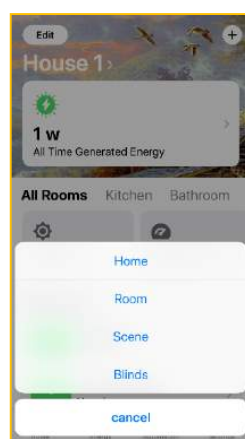

Figure 35



Figure 36

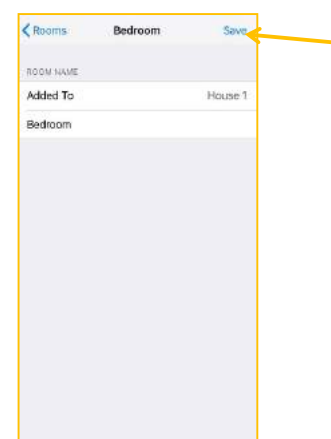

Figure 37

10.9.4. Click **Edit** to delete the room (Fig. 38).

10.9.5. Select the desired room from the list by clicking (Fig. 39).

10.9.6. Click **Delete** (Fig. 40).



Figure 38



Figure 39

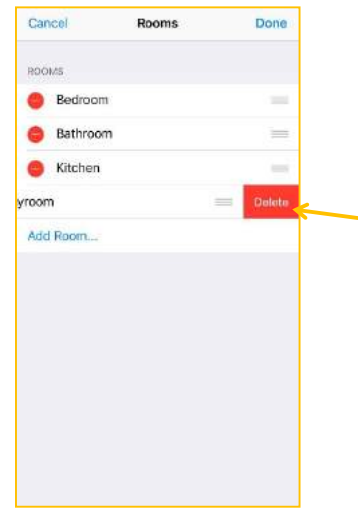

Figure 40

10.9.7. Click **Add room** (Fig. 41) to add a room to the current Home.

10.9.8. Enter the room name and click **Save** (Fig. 42).



Figure 41

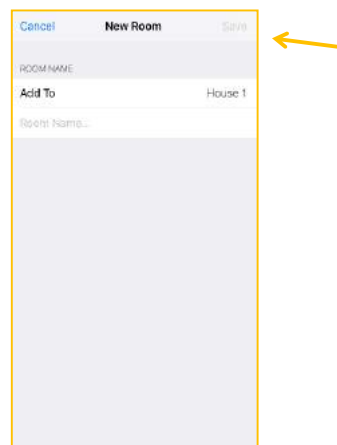

Figure 42

10.10. Edit/create operating scenario for the blinds

10.10.1. Click **Edit** in the top left corner to start (Fig. 43).

10.10.2. Select **Scene** from the menu options (Fig. 44).

10.10.3. To change setting of the scenario, click on name of the desired scenario (Fig. 45) and introduce changes (Fig. 46):

- ✔ Change the scenario icon and its name
- ✔ Delete the BLINDS that operate according to the respective scenario in a certain room by clicking
- ✔ **Add Blinds** – add new BLINDS that be operated according to the current scenario in a certain room
- ✔ **Position** – change the solar panels tilt angle and opening percentage (roll up/down)
- ✔ **When** – edit hours and days for execution of the operating scenario
- ✔ Click **Save** to save changes

10.10.4. To add a new operating scenario for the BLINDS click **Add Scene** (Fig. 45) and go through setting process as described in *para. 7*.

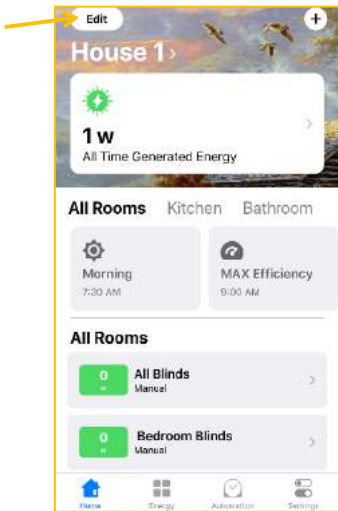

Figure 43

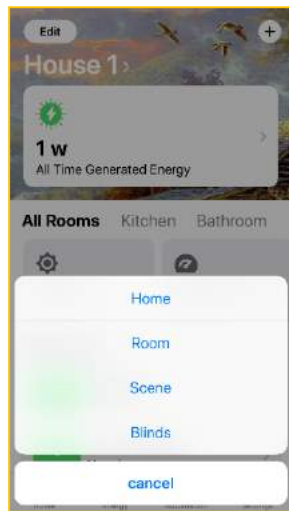

Figure 44

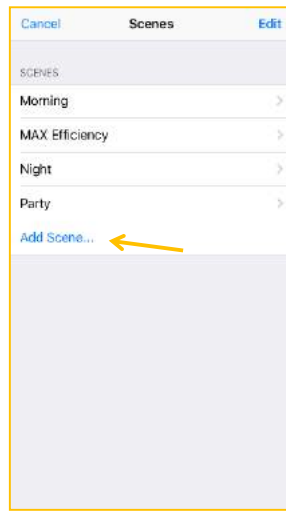

Figure 45

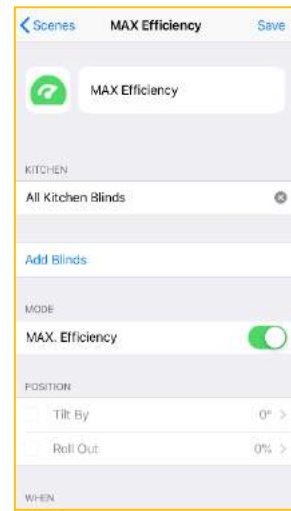



Figure 46

10.10.5. To delete an operating scenario for the BLINDS:

- ✔ Click **Edit** (Fig. 47)
- ✔ Select the scenario from the list by clicking  (Fig. 48)
- ✔ Click **Delete** (Fig. 49)

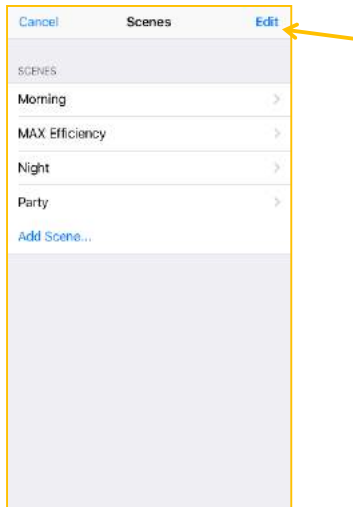

Figure 47

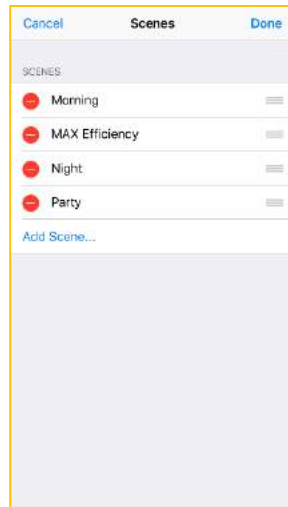

Figure 48

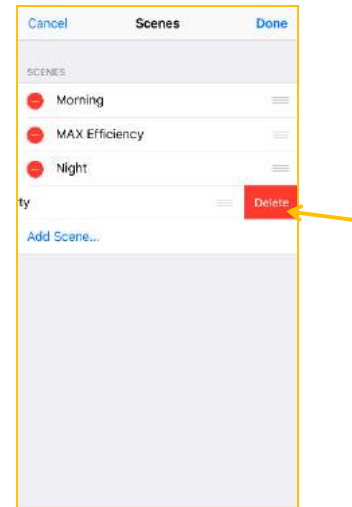

Figure 49

10.11. Edit/delete blinds

10.11.1. Click **Edit** in the top left corner to start (Fig. 50).

10.11.2. Select **Blinds** from the menu options (Fig. 51).

10.11.3. Select appropriate BLINDS from the list, edit data or delete the blinds.

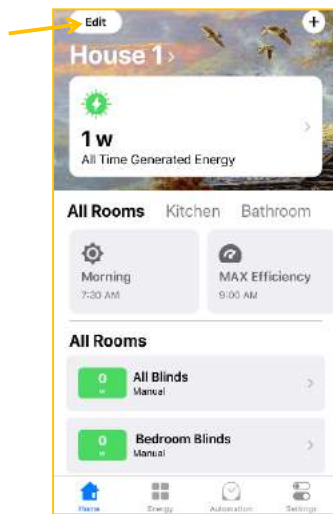

Figure 50

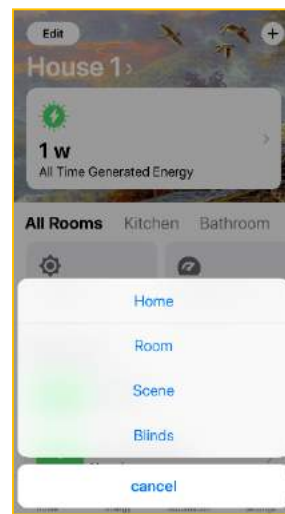

Figure 51

10.12. Overview

Figure 50

10.12.1. All Time Generated Energy

Figure 51

10.12.1. Click at **All Time Generated Energy** value (Fig. 52) or energy generation menu **Energy** (Fig. 53).

10.12.2. **All Time Generated Energy** (Fig. 54) allows viewing the amount of energy generated during the entire period of operation of BLINDS in the application. This amount is presented in equivalent of smartphone charging cycles, number of working days of a fridge or operation hours of a lamp. To share this data, click **Share Card** and select the messaging option.

10.12.3. **Real time generated energy** value displays the amount of energy accumulated at the current moment of time.

10.12.4. **Statistics** tab (Fig. 53) displays historical generation of power per day/week/month/year. To see the statistics for each individual room, click **All Rooms** tab and select the desired room. Click  to share the historical data.

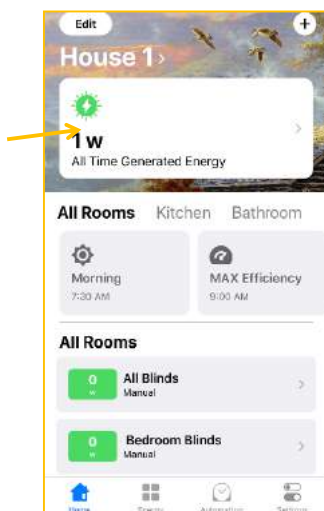

Figure 52



Figure 53

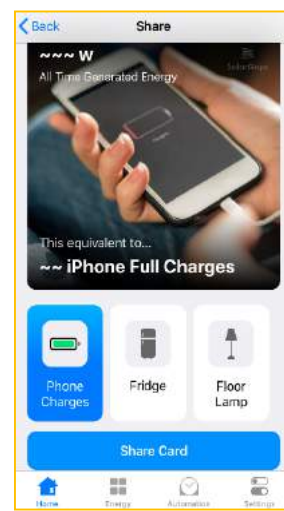

Figure 54

10.13. Overview of operating scenarios for the blinds – Automation

10.13.1. Click at **Automation** menu option for operating scenarios of BLINDS (Fig. 55).

10.13.2. The menu allows viewing all operating scenarios for the BLINDS, their execution schedule, activate or stop execution of a certain scenario as follows:

✔ **Now** – currently active scenario

✔ **Next** – scenarios to be activated at the pre-set moment of time

10.13.3. Deactivate software switch  (Fig. 56) to stop execution of the scenario.

10.13.4. Click  and select **Scenes** (Fig. 57) to edit scenarios.

10.13.5. Edit the required scenario according to para. 10.10.3.-10.10.5. (Fig. 58).

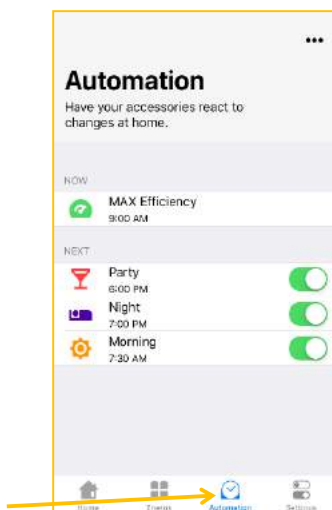

Figure 55

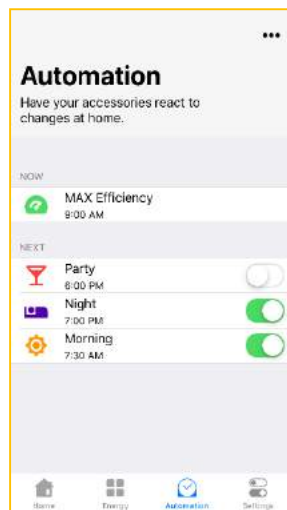

Figure 56

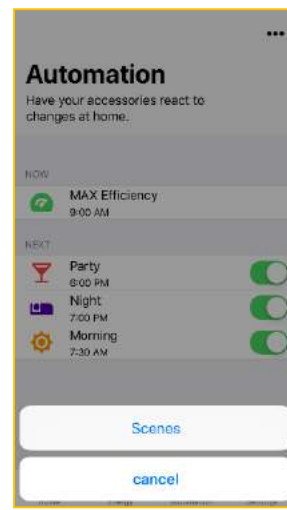

Figure 57

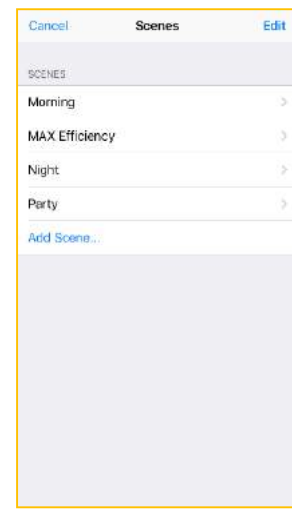

Figure 58

10.14. Overview of the application settings menu – Settings

10.14.1. Click the application **Settings** menu (Fig. 59).

10.14.2. The menu allows editing key functions of the application:

✔ Click at the user name or  icon to change name, surname, email or password. Click **Done** to save changes. Click **Sign out** to exit the account.

✔ **Devices** – view the list of BLINDS connected to your rooms and select appropriate BLINDS (Fig. 60). Click at the BLINDS name to change the BLINDS installation room, or reset the settings using **Reset Blinds** key (Fig. 61).

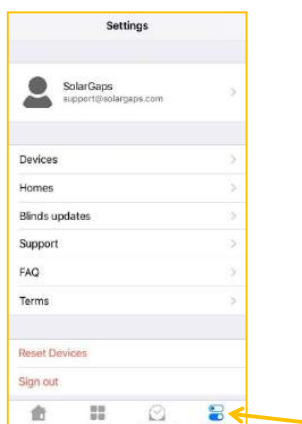

Figure 59

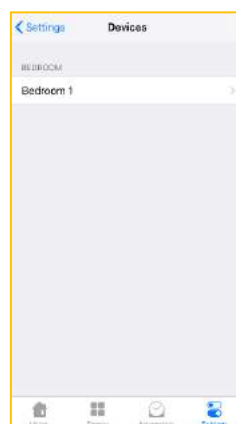

Figure 60

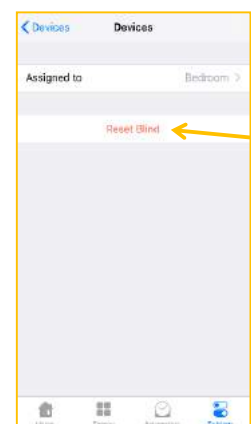

Figure 61

✔ **Homes** – switch between Homes for editing. Click **Add Home** to add a new home, or click **Edit** to delete the existing one (Fig. 62).

✔ **Blinds updates** – viewing of available updates of the Application software (Fig. 63). Click **Update** to update individual BLINDS or **Update All** to update all BLINDS.

⚠ **WARNING:** the most recent application version allows you to benefit from all functions of SolarGaps BLINDS. Check for regular updates of the application in AppStore (for IOS) or Play Market (for Android) and firmware updates to enjoy new functions and improvements.

✔ **Support** – ask for technical support in case of any questions or problems related to use of the BLINDS. Click **Start A Conversation** (Fig. 64) or  icon to start a conversation. Type your question and click **Send** to send it (Fig. 65).



Figure 62

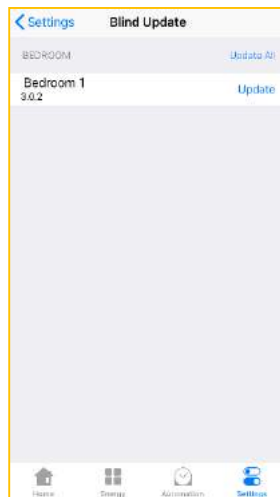

Figure 63

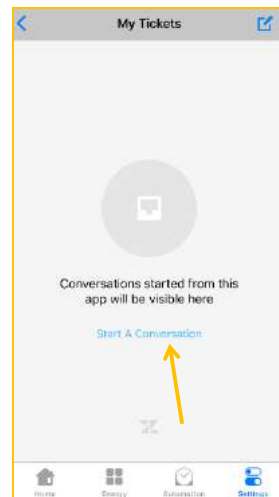

Figure 64

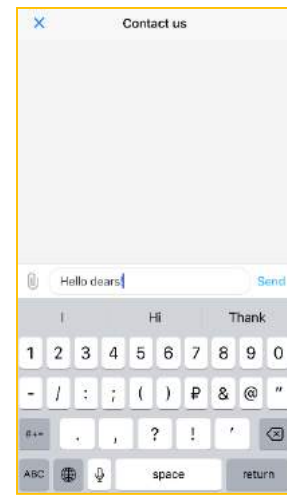



Figure 65

✔ **FAQ** – this chapter contains general information about the application, main problems and questions that are most frequently asked by users (Fig. 66). Click relevant topic (Fig. 67) to get answer (Fig. 68). For fast search type a key word in **Search** field (Fig. 69). If you can not find answer, ask the technical support service by using **Support** tab or  icon.

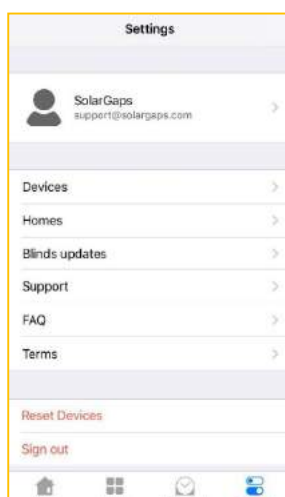

Figure 66



Figure 67

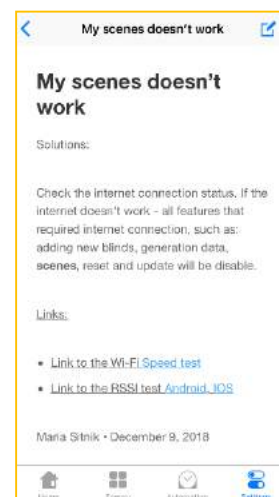

Figure 68

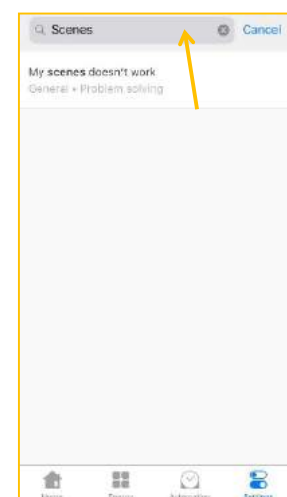

Figure 69

✔ **Terms** – terms and conditions of use of the application (Fig. 70).

✔ **Reset Devices** – click the button to reset settings of all BLINDS (Fig. 71). Click **Reset All Devices** to confirm resetting or **Cancel** to cancel resetting (Fig. 72).

✔ **Sign out** – click to sign out from the account (Fig. 71).



Figure 70

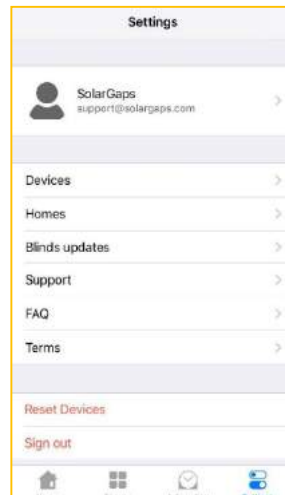

Figure 71

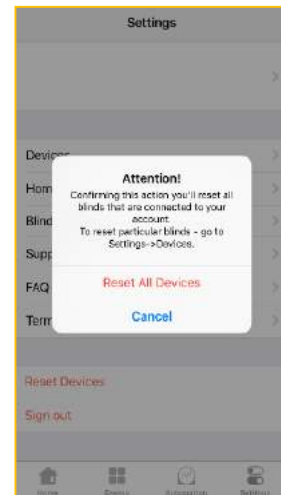

Figure 72

10.15. Controlling blinds from the application

All the connected blinds are shown in the application homepage (Fig. 73).

- ✔ If no scenarios are attributed to the BLINDS, their names are inactive (1), and the list of rooms shows standard scenario – **Manual** (2).
- ✔ The standard **Manual** scenario allows manual adjustment of the solar panels tilt angle (Fig. 74) and moving the BLINDS up or down (Fig. 75).

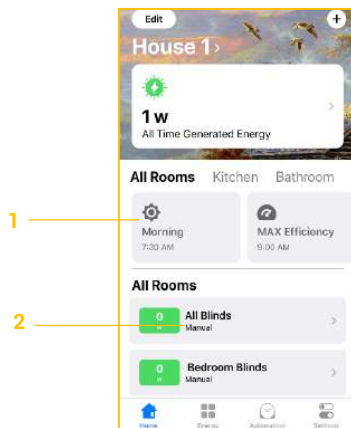

Figure 73

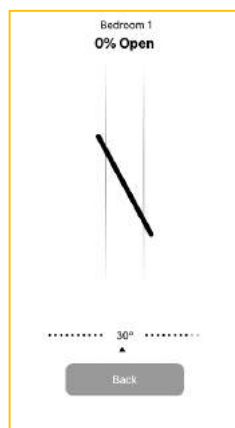

Figure 74

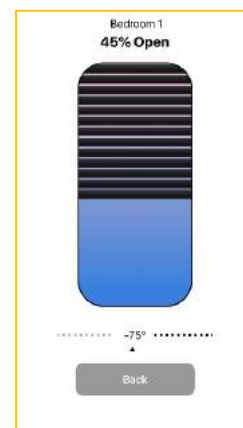

Figure 75

Use **Automation** menu to activate the operating scenario for the BLINDS in a specific room or rooms (para. 10.13), or use **Edit** tab in the application homepage (para. 10.10).

✔ The chosen scenario (Fig. 76) will be highlighted in blue (3) and shown in the BLINDS description, screen (4).

✔ Please note, that by choosing **All Rooms** tab (5) you can manually change the tilt angle and position of all BLINDS in the Home. To do this, click **All Blinds** (6) tab. If you control solar panels manually, all BLINDS will be switched to the standard **Manual** mode.

- ✔ Switch between rooms for manual adjustment of the tilt angle or position of BLINDS in a specific room (7).
- ✔ Use **Automation** menu (para. 10.13) or **Edit** tab at the application homepage (para. 10.10) to remove an operating scenario for the BLINDS in a certain room or rooms.

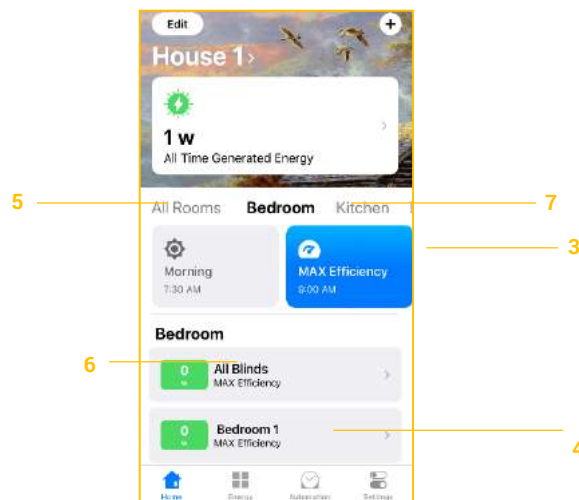

Figure 76

10.16. Information on Application usage for distributors

Distributors are recommended to create a test account, which contains settings of typical scenarios (MAX. Efficiency, Night, Morning) and main House settings (number of blinds, rooms, etc.) to ensure efficient performance and demonstration of all possibilities of the BLINDS.

The Application is designed so, that the solar panels may be controlled from any location, though the BLINDS shall be connected to a specific room of a specific House. If the BLINDS are moved to a new location, they will connect to a new Wi-Fi network, which is equal to new connection of the BLINDS to the application (see para. 10.4.).

⚠ WARNING: Reset settings for the showroom sample of the BLINDS (para. 10.14.2 - Devices) before moving it to any other location, otherwise you will not be able to establish connection in a new location.

11. Transportation rules

11.1. The blinds can be transported to the End User (or storage premises, or a building for installation) by all means of covered transport, in vertical position with observance of the handling marks on the packing to avoid physical damages of components and solar panels.

⚠ CAUTION! Take all necessary measures to prevent any physical damage, deformation or pollution of the product or its components during transportation and/or storage of the BLINDS.

11.2. Fix the BLINDS for the transportation in a way excluding any possible movement of the product and its components inside of the transporting vehicles.

12. Storage rules

12.1. The BLINDS shall be stored in a dry closed space in original manufacturer's packing at a temperature not lower than +5 °C.

 Number of rows in case of stacking: max. 2 (two).

 **IT IS PROHIBITED** to store the BLINDS as follows:

 in premises with corrosive materials;

 in places, where distance to heating equipment is less than 1 m.

12.2. The term of storage of the BLINDS in the transportation packing – one year from the shipment date.

13. Safety instructions

13.1. Read these instructions carefully.

13.2. Keep safe the Manual.

13.3. Follow all warnings.

13.3. Follow all instructions.

13.5. Do not use the equipment close to water.

13.6. Use dry cloth only to clean the product.

13.7. Do not close the ventilation apertures. Install the product following the manufacturer's instructions.

13.8. Do not use the product near heat sources including: ovens, fireplaces and other heating equipment.

13.9. Connect the product only to a grounded power network. Use only grounded power connectors.

13.10. Take measures to protect power cables against stepping on, perforating or any other damage.

13.11. Use only the components included into the delivery set.

13.12. Start-up works, servicing and repairs shall be carried out only by qualified service personnel. Maintenance is required if the system was damaged in any way, for example, damage of cable or connector, entry of fluid or foreign particles inside the product.



WARNING! - Do not dismantle side panels to avoid the electric shock. The product does not contain any internal components that require maintenance by the end user.



WARNING!

 Connect the BLINDS to the power grid using a cord with min. cross-section of 0.5 mm² and separate insulated grounding wire and plug with grounding contact.

 Ensure resistance of not more than 0.1 Ohm between the grounding element and any other metal part of the BLINDS, which may potentially be touched- and where dangerous voltages can be present.

14. Fire safety instructions

All works related to installation, connection, repairs and maintenance of the BLINDS shall be performed by qualified personnel only, in order to avoid any accidents.

The BLINDS shall be connected to the power grid using a cord with cross-section of at least 0.5 mm² with a separate insulated grounding wire and plug with grounding contact.

Only the standard and fault-free switching equipment and connectors shall be used.

The circuit breaker shall be located in a place protected from water entry and easily accessible for quick disconnection of the product from the grid.



WARNING! Attention parents! Teach your children to use the BLINDS correctly.

15. Operation conditions and useful life

15.1. Design solutions and modern materials used in the BLINDS guarantee you the absolute safety and environmental sustainability during operation, subject to compliance with the safety requirements.

15.2. The BLINDS are made of non-toxic materials and do not emit any hazardous substances into the environment during operation.

 **CAUTION!** During the winter season, at temperatures below zero Celsius, ice may be formed on surfaces of the actuation mechanisms of the BLINDS, which can damage the mechanisms or reduce their useful life. The manufacturer recommends to avoid moving the BLINDS up and down at subfreezing temperatures.

 **Manufacturer's recommendation:**

It is better to keep the BLINDS in the upper position in the winter season at subfreezing temperatures.

16. Maintenance

16.1. Maintenance of the BLINDS during the term of their operation includes works listed in Table 7 below.

Table 7

No.	Contents of works	Working materials
1.	Periodic cleaning	Use non-aggressive detergents and soft cloth

 **CAUTION!** Disconnect the BLINDS from the grid and take measures to exclude unauthorized reconnection prior to maintenance.

 **Manufacturer's recommendation:**

 For the best performance of solar panels of the BLINDS, surfaces of solar panels shall be free of visible dirt (dust, dirty leaf's, feathers, small stones, ice (in winter) and other foreign objects).

 Maintenance and repairs of the BLINDS shall be assigned to qualified personnel of service companies, who have respective licenses (please, ask the seller of our product for contacts).

 To prevent any possible failures, have you BLINDS inspected periodically (once a year) by authorized personnel.

17. Troubleshooting

 **CAUTION!** In case of any failures of the BLINDS (abnormal noise, smell or any other issues raising your concerns) stop operation of the BLINDS immediately and contact the Seller and/or Manufacturer.

 **PROHIBITED!**

 It is prohibited to make any unauthorized adjustments, repairs, re-installation and/or introduce any changes to the design of the BLINDS.

 It is prohibited to hinder movement of the slats (up/down, change of the tilt angle) with your hands or other objects.

 It is prohibited to use the BLINDS in case of any visible damages of the power cables or control devices (switches, remote controls or other devices).

 **WARNING!**

 In the summer season with high air temperatures the constant movement of slats (during 4--5 minutes) may cause overheating of the electric motor resulting in actuation of the built-in protective thermal switch. In this case the electric motor will be blocked

until cooling down to the operating temperature. Please wait for some time (approximately 15 minutes) and operation of the BLINDS will resume automatically.

✔ In case of icing of the BLINDS in the winter season, it is strongly recommended to suspend their operation in order to clean the slats, slotted side guides and mechanisms from ice.

✔ The control unit of the BLINDS turns off if the grid is deenergized. After restoration of power supply, the control unit automatically switches on the BLINDS and starts their operation according to the latest programmed parameters.

18. Warranty obligations

18.1. The warranty period for the BLINDS makes 24 months from the date of sale of the product specified in the **Warranty Certificate**. If the date of sale of the product is missing, the warranty term is calculated from the date of manufacture.

18.2. The Manufacturer guarantees the operational performance and technical specifications of the BLINDS, if the conditions of transportation, storage, installation and operation defined in this Manual will be complied with.

⚠ **CAUTION!** The warranty obligations of the Manufacturer exclude the following:

⚠ battery, even if it is included in the set of the BLINDS;

⚠ software installed for the BLINDS, even if that software was sold with the product or integrated (firmware) into the product, or included into the delivery set;

⚠ back-ups of the software and all other data that could be used during the useful life of the BLINDS. Restoration and re-installation of the mentioned software and data shall be performed by the End User at his own risk and peril.

⚠ **WARNING!** *The Manufacturer shall not be responsible* for any losses and/or damages that:

⚠ might be caused due to potential probable losses and/or damages of the software and data mentioned above;

⚠ might be caused by mobile applications used for control of the BLINDS.

18.3. In case of need of the warranty service of the BLINDS during the warranty period (a defect is found), the End User shall send request to support@solargaps.com or use the Help tab of the application.

⚠ **NOTE:**



✔ First, the End User will receive recommendations and advice for removal of the failure from the Manufacturer.

✔ In case of a reasonable claim to the product, the Seller will perform all works related to correction of defects **free of charge**, i.e. at expense of the Manufacturer (visit of personnel to the End User, if necessary, including costs of spare parts and components).





⚠ The expenses related to dismantling, installation and transportation of the damaged product during the warranty period are not reimbursed to the Buyer.

⚠ If a claim is not substantiated, the expenses for trouble-shooting and expert assessment are paid by the Buyer.



 **Notes:** Newly installed parts and/or components remain in the ownership of the End User and respective damaged ones are transferred into the Manufacturer's ownership for the following actions:

-  analysis of discovered defects (jointly with suppliers of components);
-  development and implementation of measures for avoidance of defects in the future;
-  other prospect works on improvement of the product.









 **WARNING!** The claims related to the BLINDS quality are accepted for consideration, and the warranty service is provided under the following conditions:

-  absence of physical damages to the product;
-  presentation of an application in a free format describing the following:
 - essence of the claim (brief description of the defect);
 - date and circumstances related to detection of the defect;
 - if possible, please attach photos or video showing the defect to the application form;
 - information about the End User/Buyer of the product, actual address and contact phone numbers;
 - information about the Installer (Installation Service Provider) of the product, his actual address and contact phone numbers;
-  correctly and clearly filled **Warranty Certificate** (Annex 1 to the Manual) specifying the model and serial number of the product, date of sale, signed and stamped by the Seller and signed by the Buyer;
-  availability of the original document confirming purchase of the product (invoice, receipt).

 **Notes:**

-  If the date of sale is missing in the **Warranty Certificate**, the warranty term is calculated from the date of manufacture of the product;
-  The information shall be sent to **support@solargaps.com**.
-  The service centre reserves the right to deny a request for warranty service or repairs, if the documents mentioned above will not be presented.

 **WARNING: The warranty for the BLINDS does not cover the following cases:**

-  damage to the product due to force-majeure circumstances (natural disaster, fire, flood, earthquake, electrostatic discharge, military actions, etc.);
-  improper installation and/or connection of the product;
-  attempts and/or traces of repairs performed by unauthorized persons;
-  readjustment, change of construction and/or circuit design, re-installation or alteration (modernization) of the product that are not authorized or approved by the Manufacturer;
-  physical damages or their consequences;
-  overload of the BLINDS resulting from incorrect assessment of the voltage and/or power of devices consuming the electrical power generated by the product;
-  product breakage resulting from its connection to the grid, which does not comply with the requirements specified in this Manual;
-  damages to the product due to actions or failure to act by the End User and/or other persons;
-  damages of the product due to penetration of foreign objects, animals or insects, fluids, stone or brick chippings, waste and other solid particles;

❌ violation of rules of the product operation specified in this Manual.

⚠️ **WARNING: In no event will the Manufacturer be liable for:**

❌ any -special, accidental, penal or indirect losses of any -type, including without limitation income or profit loss, damage to property and claims of the Buyer or any -other third parties, even if the Manufacturer has been informed about the possibility of such losses;

❌ any potential damages caused by the product directly or indirectly to people, animals or property, if such damages results from violation of the rules or conditions of installation and/or operation of the BLINDS, or intentional or unintentional actions of the End User or any third parties.

⚠️ **NOTE:** This warranty does not limit in any way the rights of the End User granted by the legislation currently in force.

ℹ️ After the end of the warranty period the Manufacturer may provide post-warranty service to the Buyer at the expense of the latter. For this purpose the Buyer shall contact his local Seller's representative and sign a respective agreement.

19. Disposal

Dispose of the product in accordance with the guidelines for disposal of electrical and electronic household appliances in force in the country of use.



This symbol on the product or on the packing indicates that it is not allowed to dispose of the product in the ordinary household waste. Bring the product to an electrical and electronic waste collection/recycling facility. Proper disposal of this product will contribute to prevention of potential negative effect on the environment and human health due to improper disposal.

WARRANTY CERTIFICATE

Warranty Certificate No. _____
Product Model _____
Date of manufacture _____
Manufacturer _____

WARNING!

When purchasing the product, please, request for testing of its operability. Check the completeness and correctness of entries in this Warranty Certificate.

Fields marked with * are mandatory for filling.

INFORMATION ABOUT THE SELLER

Seller _____
Addresses and phone numbers _____
Date of sale * _____
Payment document * _____
Full name of the SELLER's Representative _____
Signature * _____
Date * _____

Place of Stamp

EC Declaration of Conformity

STANA DoC.021.2018 Dated «10» September 2018

The following products have been tested by us with the listed standards and found in compliance with European Parliament and of the Council of the European Union Low Voltage Directive 2014/35/EU, Electromagnetic Compatibility Directive 2014/30/EU.

Manufacturer name: Limited liability company SolarGaps

Manufacturer address: Magnitogorska str., 1A letter 2,
Kyiv, Ukraine, 02606

Product: Smart Solar blinds

Brand: TM SolarGaps

Type/model: SGV1C80-6-W-(WxH)(color)(QM)
SGV1C80-10-W-(WxH)(color)(QM)
SGV1C80-20-W-(WxH)(color)(QM)
SGV1C80-6-R-(WxH)(color)(QM)
SGV1C80-10-R-(WxH)(color)(QM)
SGV1C80-20-R-(WxH)(color)(QM)

Applied standards: EN 60335-1:2012; EN 60335-2-97:2006; EN 61000-3-2:2014; EN 61000-3-3:2013; EN 55014-1:2006; EN 55014-2:1997

The statement is based on a single evaluation of one sample of above mentioned products. It does not imply an assessment of the whole production and does not permit the use of the Test lab's logo.

The manufacturer should ensure that all products in series production are in conformity with the product sample detailed in this report. Technical report and documentation are at the applicant's disposal.

Responsibility for product safety and compliance with the requirements of the Directives: European Parliament and of the Council of the European Union Low Voltage Directive 2014/35/EU, Electromagnetic Compatibility Directive 2014/30/EU and harmonized standards are issued under the sole responsibility of the manufacturer.



The declaration is valid until the introduction of modifications of the technical parameters of the products and production process.

Other relevant directives have to be observed.

Test report: № L464-2/08-18 dated "30" August 2018

Issued Date: "10" September 2018

Name of authorised representative

STANA (stana-certification.eu)

Loccumer Straße 55, 30519 Hannover, Germany

EU VAT number: DE316050721

Tel.: +49 511 87457693 Fax: +49 511 87457692

STANA

CERTIFICATION

STANA-CERTIFICATION.EU

Loccumer Straße 55, 30519 Hannover

Inhaber Olego Nechepurenko,

USt-ID: DE316050721

Tel.: +49 511 87457693

Fax: +49 511 87457692

O. Nechepurenko

office@stana-certification.eu

STANA
CERTIFICATION



Declaration of Performance

No: DoP.022.2018

305/2011/EU Construction Products Regulation



1. Unique identification code of the product-type:

SGV1C80-6-W-(WxH)(color)(QM); SGV1C80-10-W-(WxH)(color)(QM); SGV1C80-20-W-(WxH)(color)(QM);
SGV1C80-6-R-(WxH)(color)(QM); SGV1C80-10-R-(WxH)(color)(QM); SGV1C80-20-R-(WxH)(color)(QM)

2. Type, batch or serial number or any other element allowing identification of the construction product as required under Article 11(4):

Smart Solar blinds

3. Intended use or uses of the construction product, in accordance with the applicable harmonized technical specification, as foreseen by the manufacturer:

External use in buildings and other construction works

4. Name, registered trade name or registered trade mark and contact address of the manufacturer as required under Article 11(5):

Limited liability company SolarGaps
str. Magnitogorska, 1A letter 2, Kyiv, Ukraine, 02606

TM SolarGaps

Tel.: +38 067 333 82 33

e-mail: hello@solargaps.com

5. Where applicable, name and contact address of the authorized representative whose mandate covers the tasks specified in Article 12(2):

STANA (stana-certification.eu)

Loccumer Straße 55, 30519 Hannover, Germany

EU VAT number: DE316050721

Tel.: +49 511 87457693 Fax: +49 511 87457692

e-mail: office@stana-certification.eu

6. System or systems of assessment and verification of constancy of performance of the construction product as set out in CPR (305/2011/EU), Annex V:

System 4

7. Notified body: **Not applicable. Determination of product type and factory production control are held by the manufacturer.**

8. Declared performance:

Essential characteristics	Performance	Harmonized technical specification
Resistance to wind loads	Class 2	EN 13561
Total solar energy transmittance g_{tot}	0,11	

9. The performance of the product identified in points 1 and 2 is in conformity with the declared performance in point 8.

This declaration of performance is issued under the sole responsibility of the manufacturer identified in point 4.

Signed for and on behalf of the authorized representative by

Authorized representative: STANA

Name and function: Dmytro Nechepurenko, Inhaber

Place / Date: Hannover, Germany, 2018, 10 September

Signature / Stamp:



INFORMATION FOR NOTES